

FLOKLU PROFİLLER GLASS RUN CHANNEL PROFILES

Ozon ve her türlü hava şartlarına göre hazırlanmış karışımdan üretilen profilin polüretan yapıştırıcı sürülen yüzeyine elektrostatik olarak yönlendirilmiş milyonlarca fiberin yerleştirilip, pişirilmesi ile üretilir. Floklu fitillerin tasarımı yapılırken, minimum geçirgenlik ve sürtünme kuvveti, maksimum ses izolasyonu, kolay ve hızlı montaj kriterleri gözönüne alınır ve uygulamalarla fitil fonksiyonu test edilerek seri üretime geçilir.

Malzeme

- EPDM Kauçuk, 65±5 Shore A, Siyah
- Polyamid Flok ,Siyah

Millions of fibers are electrostatically positioned and driven into a polyurethane adhesive on a section made of live rubber resisted to ozone and weathering and are then cured. Sealing systems guide the window precisely with minimal sliding resistance, and ensure impermeability even at high contribute to reduction of drag coefficient and minimising wind noise to meet design requirements. The function of the sealing system is tested before transferring to serial production.

Material

- EPDM Rubber, 65±5 Shore A, Black
- Polyamide Flock, Black

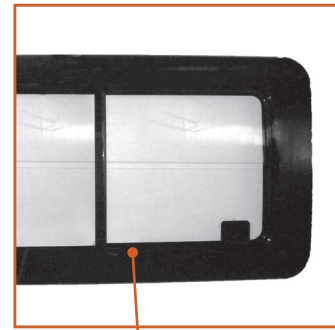

METAL TAKVİYELİ FLOKLU FİTİLLER

GLASS RUN CHANNEL PROFILES WITH METAL CARRIER



| Teknik Resim Technical Drawing | Kod Reference | Eski Kodu Old Ref. | Renk Color | Malzeme Material | Ambalaj Packing (mt.) |
|---|------------------|-----------------------|----------------|---------------------|--------------------------|
|  | F1.001 | M223102400 | SİYAH BLACK | EPDM | 50 |
|  | F1.002 | M223103600 | SİYAH BLACK | EPDM | 50 |
|  | F1.003 | M223103900 | SİYAH BLACK | EPDM | 5X25=125 |
|  | F1.004 | M223104000 | SİYAH BLACK | EPDM | 5X25=125 |
|  | F1.005 | M223106100 | SİYAH BLACK | EPDM | 5X25=125 |
|  | F1.006 | M223106300 | SİYAH BLACK | EPDM | 5 |

METAL TAKVİYELİ FLOKLU FİTİLLER

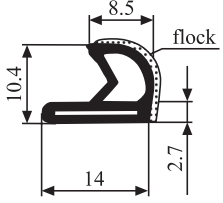
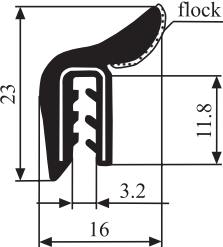
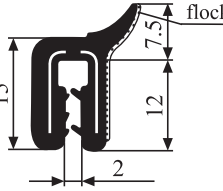
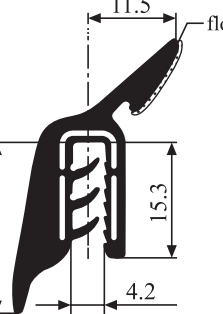
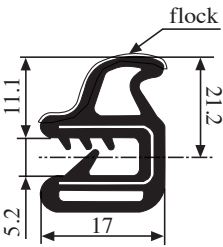
GLASS RUN CHANNEL PROFILES WITH METAL CARRIER

| Teknik Resim Technical Drawing | Kod Reference | Eski Kodu Old Ref. | Renk Color | Malzeme Material | Ambalaj Packing (mt.) |
|---|------------------|-----------------------|----------------|---------------------|--------------------------|
|  | F1.007 | M223108200 | SİYAH BLACK | EPDM | 100 |
|  | F1.008 | M223108701 | SİYAH BLACK | EPDM | 75 |
|  | F1.009 | - | SİYAH BLACK | EPDM | 75 |
|  | F1.010 | - | SİYAH BLACK | EPDM | 50 |
|  | F1.011 | - | SİYAH BLACK | EPDM | 50 |

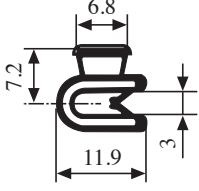
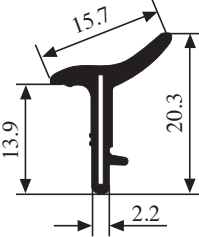
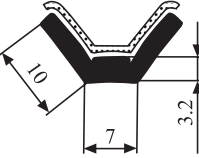
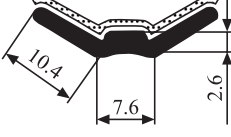
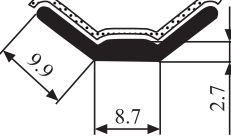
FLOKLU FİTİLLER / GLASS RUN CHANNEL PROFILES

| Teknik Resim Technical Drawing | Kod Reference | Eski Kodu Old Ref. | Renk Color | Malzeme Material | Ambalaj Packing (mt.) |
|---|------------------|-----------------------|----------------|---------------------|--------------------------|
|  | F1.013 | - | SİYAH BLACK | EPDM | 200 |
|  | F1.014 | - | SİYAH BLACK | EPDM | 100 |
|  | F2.001 | M223105400 | SİYAH BLACK | EPDM | 100 |
|  | F2.002 | M223105500 | SİYAH BLACK | EPDM | 100 |
|  | F2.003 | M223105100 | SİYAH BLACK | EPDM | 100 |
|  | F2.004 | M223103100 | SİYAH BLACK | EPDM | 100 |

FLOKLU FİTİLLER / GLASS RUN CHANNEL PROFILES

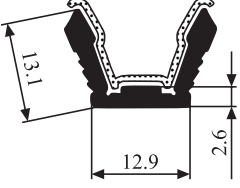
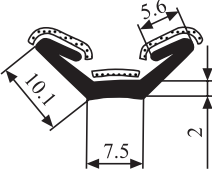
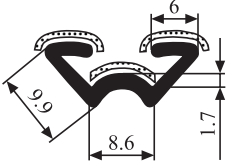
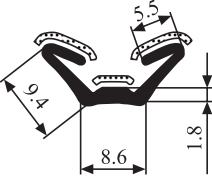
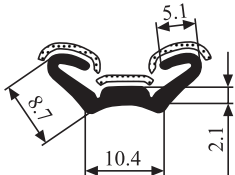
| Teknik Resim Technical Drawing | Kod Reference | Eski Kodu Old Ref. | Renk Color | Malzeme Material | Ambalaj Packing (mt.) |
|---|------------------|-----------------------|----------------|---------------------|--------------------------|
|  | F2.005 | M223105300 | SİYAH BLACK | EPDM | 100 |
|  | F2.006 | M223107500 | SİYAH BLACK | EPDM | 100 |
|  | F2.007 | M223104400 | SİYAH BLACK | EPDM | 100 |
|  | F2.008 | M223101400 | SİYAH BLACK | EPDM | 100 |
|  | F2.009 | M223102100 | SİYAH BLACK | EPDM | 200 |
|  | F2.010 | M223101700 | SİYAH BLACK | EPDM | 100 |
|  | F2.011 | M223104100 | SİYAH BLACK | EPDM | 100 |

FLOKLU FİTİLLER / GLASS RUN CHANNEL PROFILES

| Teknik Resim Technical Drawing | Kod Reference | Eski Kodu Old Ref. | Renk Color | Malzeme Material | Ambalaj Packing (mt.) |
|---|------------------|-----------------------|----------------|---------------------|--------------------------|
|  | F2.012 | M223105000 | SİYAH BLACK | EPDM | 100 |
|  | F2.013 | M223109000 | SİYAH BLACK | EPDM | 100 |
|  | F2.014 | M223108600 | SİYAH BLACK | EPDM | 100 |
|  | F2.015 | M223108900 | SİYAH BLACK | EPDM | 100 |
|  | F2.016 | M223103700 | SİYAH BLACK | EPDM | 100 |
|  | F2.017 | M223100200 | SİYAH BLACK | EPDM | 100 |

FLOKLU FİTİLLER / GLASS RUN CHANNEL PROFILES

| Teknik Resim Technical Drawing | Kod Reference | Eski Kodu Old Ref. | Renk Color | Malzeme Material | Ambalaj Packing (mt.) |
|---|------------------|-----------------------|----------------|---------------------|--------------------------|
|  | F2.018 | M223109600 | SİYAH BLACK | EPDM | 100 |
|  | F2.019 | M223100300 | SİYAH BLACK | EPDM | 100 |
|  | F2.020 | M223100700 | SİYAH BLACK | EPDM | 50 |
|  | F2.021 | M223100800 | SİYAH BLACK | EPDM | 100 |
|  | F2.022 | M223102500 | SİYAH BLACK | EPDM | 100 |
|  | F2.023 | M223106000 | SİYAH BLACK | EPDM | 100 |

FLOKLU FİTİLLER / GLASS RUN CHANNEL PROFILES

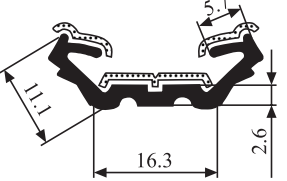
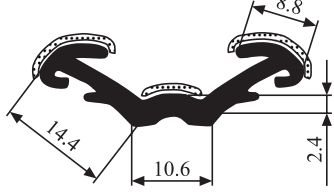
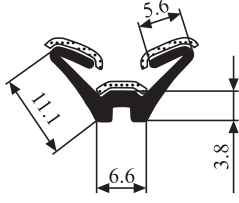
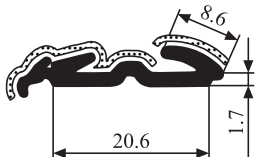
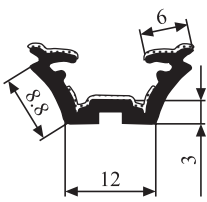
| Teknik Resim Technical Drawing | Kod Reference | Eski Kodu Old Ref. | Renk Color | Malzeme Material | Ambalaj Packing (mt.) |
|---|------------------|-----------------------|----------------|---------------------|--------------------------|
|  | F2.024 | M223101900 | SİYAH BLACK | EPDM | 100 |
|  | F2.025 | M223106500 | SİYAH BLACK | EPDM | 50 |
|  | F2.026 | M223109100 | SİYAH BLACK | EPDM | 100 |
|  | F2.027 | M223109300 | SİYAH BLACK | EPDM | 100 |
|  | F2.028 | M223103800 | SİYAH BLACK | EPDM | 100 |
|  | F2.029 | M223109700 | SİYAH BLACK | EPDM | 100 |

FLOKLU FİTİLLER / GLASS RUN CHANNEL PROFILES

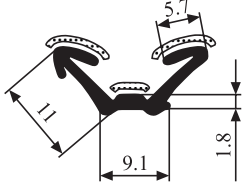
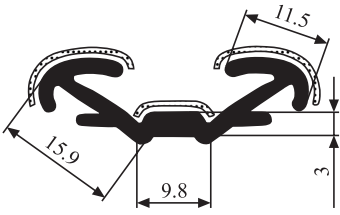
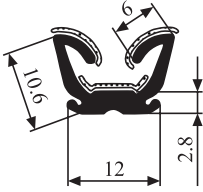
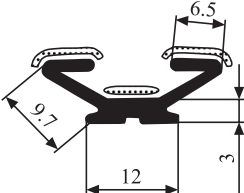
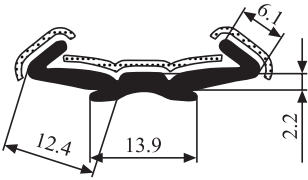
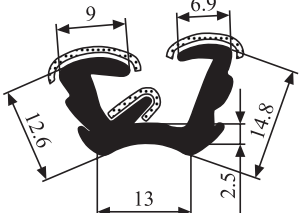
| Teknik Resim Technical Drawing | Kod Reference | Eski Kodu Old Ref. | Renk Color | Malzeme Material | Ambalaj Packing (mt.) |
|---|------------------|-----------------------|----------------|---------------------|--------------------------|
|  | F2.030 | M223102600 | SİYAH BLACK | EPDM | 100 |
|  | F2.031 | M223107700 | SİYAH BLACK | EPDM | 50 |
|  | F2.032 | M223108400 | SİYAH BLACK | EPDM | 100 |
|  | F2.033 | M223103500 | SİYAH BLACK | EPDM | 100 |
|  | F2.034 | M223107900 | SİYAH BLACK | EPDM | 50 |
|  | F2.035 | M223104900 | SİYAH BLACK | EPDM | 100 |

FLOKLU FİTİLLER / GLASS RUN CHANNEL PROFILES

| Teknik Resim Technical Drawing | Kod Reference | Eski Kodu Old Ref. | Renk Color | Malzeme Material | Ambalaj Packing (mt.) |
|-----------------------------------|------------------|-----------------------|----------------|---------------------|--------------------------|
| | F2.036 | M223109400 | SİYAH BLACK | EPDM | 100 |
| | F2.037 | M223108000 | SİYAH BLACK | EPDM | 50 |
| | F2.038 | M223104200 | SİYAH BLACK | EPDM | 100 |
| | F2.039 | M223101300 | SİYAH BLACK | EPDM | 100 |
| | F2.040 | M223100100 | SİYAH BLACK | EPDM | 100 |
| | F2.041 | M223104500 | SİYAH BLACK | EPDM | 100 |

FLOKLU FİTİLLER / GLASS RUN CHANNEL PROFILES

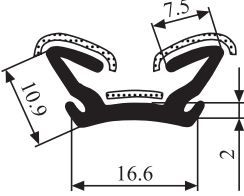
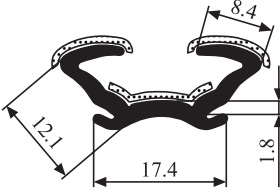
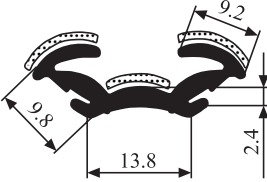
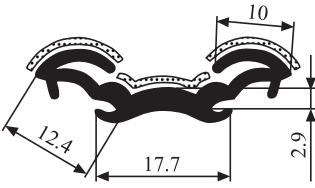
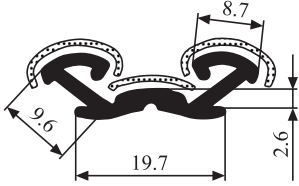
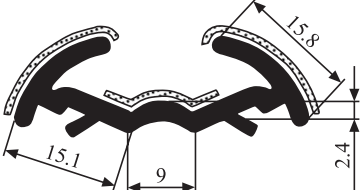
| Teknik Resim Technical Drawing | Kod Reference | Eski Kodu Old Ref. | Renk Color | Malzeme Material | Ambalaj Packing (mt.) |
|---|------------------|-----------------------|----------------|---------------------|--------------------------|
|  | F2.042 | M223107600 | SİYAH BLACK | EPDM | 100 |
|  | F2.043 | M223108300 | SİYAH BLACK | EPDM | 100 |
|  | F2.044 | M223103000 | SİYAH BLACK | EPDM | 100 |
|  | F2.045 | M223105200 | SİYAH BLACK | EPDM | 50 |
|  | F2.046 | M223107800 | SİYAH BLACK | EPDM | 50 |
|  | F2.047 | M223102700 | SİYAH BLACK | EPDM | 50 |

FLOKLU FİTİLLER / GLASS RUN CHANNEL PROFILES

| Teknik Resim Technical Drawing | Kod Reference | Eski Kodu Old Ref. | Renk Color | Malzeme Material | Ambalaj Packing (mt.) |
|-----------------------------------|------------------|-----------------------|----------------|---------------------|--------------------------|
| | F2.048 | M223107200 | SİYAH BLACK | EPDM | 50 |
| | F2.049 | M223100400 | SİYAH BLACK | EPDM | 100 |
| | F2.050 | M223101600 | SİYAH BLACK | EPDM | 50 |
| | F2.051 | M223102800 | SİYAH BLACK | EPDM | 50 |
| | F2.052 | M223105700 | SİYAH BLACK | EPDM | 50 |
| | F2.053 | M223105800 | SİYAH BLACK | EPDM | 50 |

FLOKLU FİTİLLER / GLASS RUN CHANNEL PROFILES

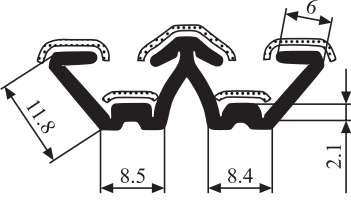
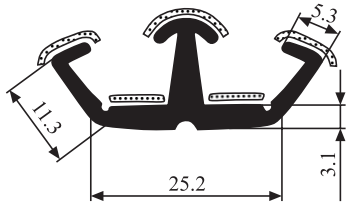
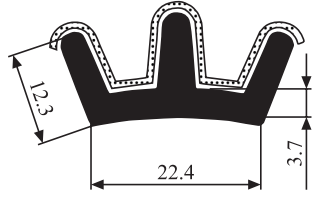
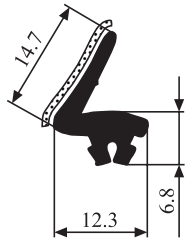
| Teknik Resim Technical Drawing | Kod Reference | Eski Kodu Old Ref. | Renk Color | Malzeme Material | Ambalaj Packing (mt.) |
|---|------------------|-----------------------|----------------|---------------------|--------------------------|
|  | F2.054 | M223107400 | SİYAH BLACK | EPDM | 50 |
|  | F2.055 | M223105600 | SİYAH BLACK | EPDM | 50 |
|  | F2.056 | M223100500 | SİYAH BLACK | EPDM | 50 |
|  | F2.057 | M223100550 | SİYAH BLACK | EPDM | 50 |
|  | F2.058 | M223100600 | SİYAH BLACK | EPDM | 50 |
|  | F2.059 | M223100900 | SİYAH BLACK | EPDM | 100 |

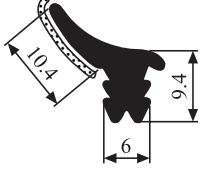
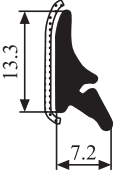
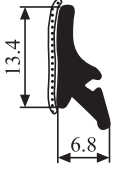
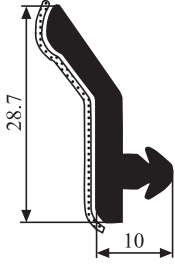
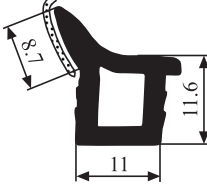
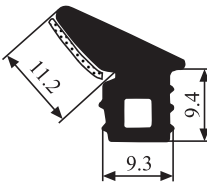

FLOKLU FİTİLLER / GLASS RUN CHANNEL PROFILES

| Teknik Resim Technical Drawing | Kod Reference | Eski Kodu Old Ref. | Renk Color | Malzeme Material | Ambalaj Packing (mt.) |
|---|------------------|-----------------------|----------------|---------------------|--------------------------|
|  | F2.060 | M223101000 | SİYAH BLACK | EPDM | 100 |
|  | F2.061 | M223101100 | SİYAH BLACK | EPDM | 200 |
|  | F2.062 | M223108500 | SİYAH BLACK | EPDM | 200 |
|  | F2.063 | M223101200 | SİYAH BLACK | EPDM | 50 |
|  | F2.064 | M223101500 | SİYAH BLACK | EPDM | 100 |
|  | F2.065 | M223106800 | SİYAH BLACK | EPDM | 100 |

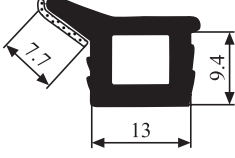
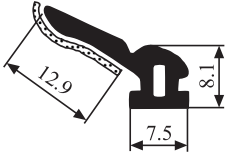
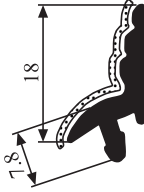
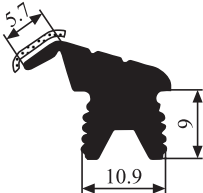
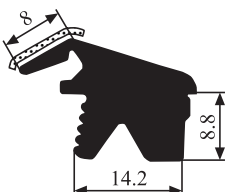
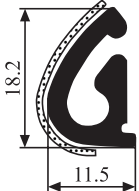
FLOKLU FİTİLLER / GLASS RUN CHANNEL PROFILES

| Teknik Resim Technical Drawing | Kod Reference | Eski Kodu Old Ref. | Renk Color | Malzeme Material | Ambalaj Packing (mt.) |
|---|------------------|-----------------------|----------------|---------------------|--------------------------|
|  | F2.066 | M223106900 | SİYAH BLACK | EPDM | 100 |
|  | F2.067 | M223101800 | SİYAH BLACK | EPDM | 200 |
|  | F2.068 | M223102000 | SİYAH BLACK | EPDM | 100 |
|  | F2.069 | M223102200 | SİYAH BLACK | EPDM | 100 |
|  | F2.070 | M223102300 | SİYAH BLACK | EPDM | 100 |
|  | F2.071 | M223103300 | SİYAH BLACK | EPDM | 100 |

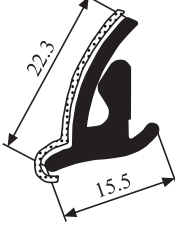
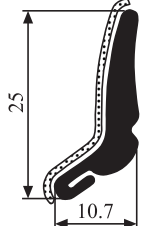
FLOKLU FİTİLLER / GLASS RUN CHANNEL PROFILES

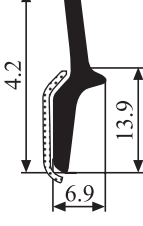
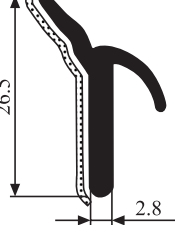
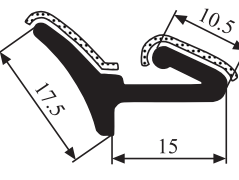
| Teknik Resim Technical Drawing | Kod Reference | Eski Kodu Old Ref. | Renk Color | Malzeme Material | Ambalaj Packing (mt.) |
|---|------------------|-----------------------|----------------|---------------------|--------------------------|
|  | F2.072 | M223103400 | SİYAH BLACK | EPDM | 100 |
|  | F2.073 | M223104300 | SİYAH BLACK | EPDM | 100 |
|  | F2.074 | M223105900 | SİYAH BLACK | EPDM | 100 |
|  | F2.075 | M223106400 | SİYAH BLACK | EPDM | 200 |
|  | F2.076 | M223108100 | SİYAH BLACK | EPDM | 100 |
|  | F2.077 | M223104600 | SİYAH BLACK | EPDM | 100 |

FLOKLU FİTİLLER / GLASS RUN CHANNEL PROFILES

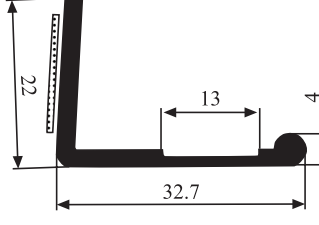
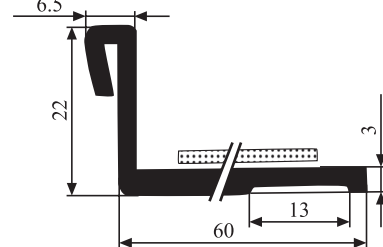
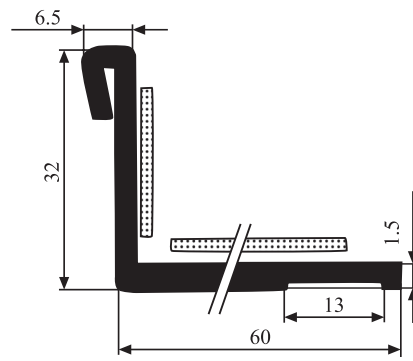
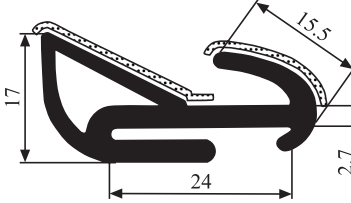
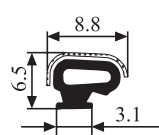
| Teknik Resim Technical Drawing | Kod Reference | Eski Kodu Old Ref. | Renk Color | Malzeme Material | Ambalaj Packing (mt.) |
|---|------------------|-----------------------|----------------|---------------------|--------------------------|
|  | F2.078 | M223106600 | SİYAH BLACK | EPDM | 25 |
|  | F2.079 | M223106700 | SİYAH BLACK | EPDM | 25 |
|  | F2.080 | M223107000 | SİYAH BLACK | EPDM | 25 |
|  | F2.081 | M223102900 | SİYAH BLACK | EPDM | 50 |
|  | F2.082 | M223108800 | SİYAH BLACK | EPDM | 50 |

FLOKLU FİTİLLER / GLASS RUN CHANNEL PROFILES

| Teknik Resim Technical Drawing | Kod Reference | Eski Kodu Old Ref. | Renk Color | Malzeme Material | Ambalaj Packing (mt.) |
|---|------------------|-----------------------|----------------|---------------------|--------------------------|
|  | F2.083 | M223107300 | SİYAH BLACK | EPDM | 100 |
|  | F2.084 | M223109200 | SİYAH BLACK | EPDM | 100 |
|  | F2.085 | M223109800 | SİYAH BLACK | EPDM | 50 |
|  | F2.086 | M223106200 | SİYAH BLACK | EPDM | 100 |
|  | F2.087 | M223107100 | SİYAH BLACK | EPDM | 50 |
|  | F2.089 | - | SİYAH BLACK | EPDM | 150 |

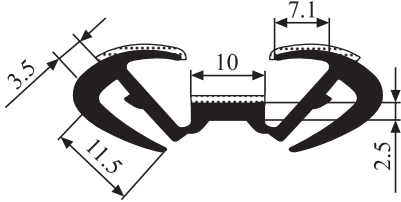
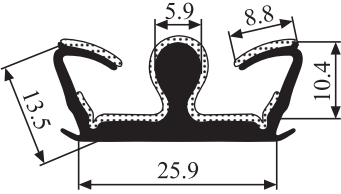
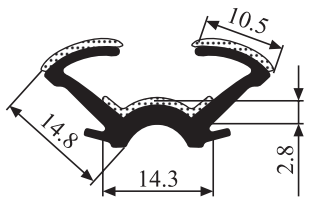
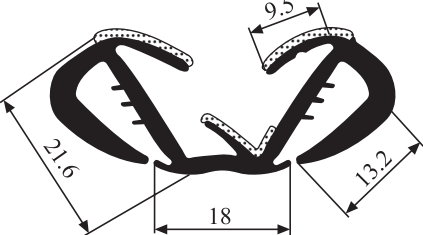
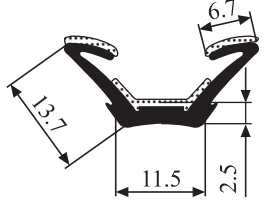
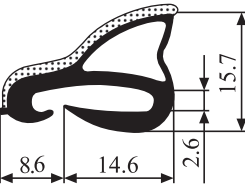

FLOKLU FİTİLLER / GLASS RUN CHANNEL PROFILES

| Teknik Resim Technical Drawing | Kod Reference | Eski Kodu Old Ref. | Renk Color | Malzeme Material | Ambalaj Packing (mt.) |
|---|------------------|-----------------------|----------------|---------------------|--------------------------|
|  | F2.090 | - | SİYAH BLACK | EPDM | 50 |
|  | F2.091 | - | SİYAH BLACK | EPDM | 50 |
|  | F2.092 | - | SİYAH BLACK | EPDM | 50 |
|  | F2.093 | - | SİYAH BLACK | EPDM | 50 |
|  | F2.094 | - | SİYAH BLACK | EPDM | 100 |
|  | F2.095 | - | SİYAH BLACK | EPDM | 50 |

FLOKLU FİTİLLER / GLASS RUN CHANNEL PROFILES

| Teknik Resim Technical Drawing | Kod Reference | Eski Kodu Old Ref. | Renk Color | Malzeme Material | Ambalaj Packing (mt.) |
|---|------------------|-----------------------|----------------|---------------------|--------------------------|
|  | F2.096 | - | SİYAH BLACK | EPDM | 50 |
|  | F2.097 | - | SİYAH BLACK | EPDM | 200 |
|  | F2.098 | - | SİYAH BLACK | EPDM | 50 |
|  | F2.099 | - | SİYAH BLACK | EPDM | 100 |
|  | F2.100 | - | SİYAH BLACK | EPDM | 100 |
|  | F2.101 | - | SİYAH BLACK | EPDM | 100 |

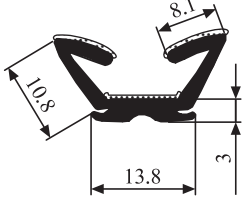
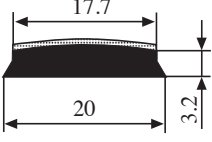
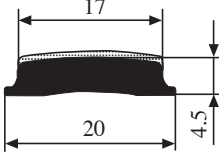
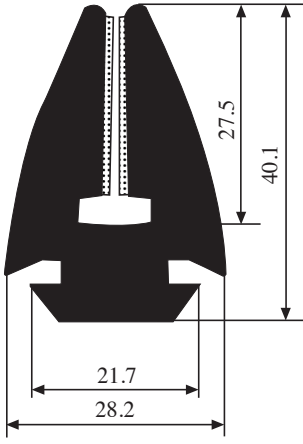
FLOKLU FİTİLLER / GLASS RUN CHANNEL PROFILES

| Teknik Resim Technical Drawing | Kod Reference | Eski Kodu Old Ref. | Renk Color | Malzeme Material | Ambalaj Packing (mt.) |
|---|------------------|-----------------------|----------------|---------------------|--------------------------|
|  | F2.102 | - | SİYAH BLACK | EPDM | 100 |
|  | F2.103 | - | SİYAH BLACK | EPDM | 200 |
|  | F2.104 | - | SİYAH BLACK | EPDM | 200 |
|  | F2.105 | - | SİYAH BLACK | EPDM | 20 |
|  | F2.106 | - | SİYAH BLACK | EPDM | 50 |

FLOKLU FİTİLLER / GLASS RUN CHANNEL PROFILES

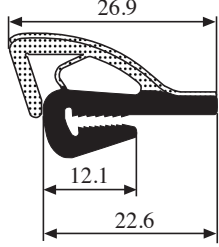
| Teknik Resim Technical Drawing | Kod Reference | Eski Kodu Old Ref. | Renk Color | Malzeme Material | Ambalaj Packing (mt.) |
|---|------------------|-----------------------|----------------|---------------------|--------------------------|
|  | F2.107 | - | SİYAH BLACK | EPDM | 100 |
|  | F2.108 | - | SİYAH BLACK | EPDM | 50 |
|  | F2.109 | - | SİYAH BLACK | EPDM | 25 |
|  | F2.110 | - | SİYAH BLACK | EPDM | 100 |
|  | F2.111 | - | SİYAH BLACK | EPDM | 100 |

FLOKLU FİTİLLER / GLASS RUN CHANNEL PROFILES

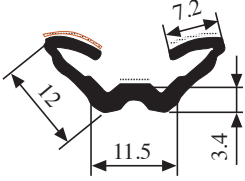
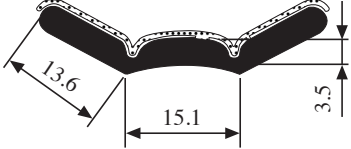
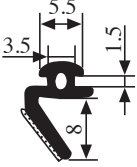
| Teknik Resim Technical Drawing | Kod Reference | Eski Kodu Old Ref. | Renk Color | Malzeme Material | Ambalaj Packing (mt.) |
|---|------------------|-----------------------|----------------|---------------------|--------------------------|
|  | F2.112 | - | SİYAH BLACK | EPDM | 100 |
|  | F2.113 | - | SİYAH BLACK | EPDM | 100 |
|  | F2.114 | - | SİYAH BLACK | EPDM | 200 |