

METAL TAKVİYELİ KAPI PROFİLLERİ DOOR SEALING PROFILES WITH METAL CARRIER

Kapı sızdırmazlık fitilleri günümüz teknolojik gelişme ve maksimum müşteri beklentilerine paralel olarak;

- Minimum geçirgenlik,
- Maksimum ses izolasyonu,
- Düşük kapanma kuvveti,
- Titreşimsiz sürüş,
- Geniş toleranslı boşlukları kapatabilme,
- Kolay ve hızlı montaj,

özelliklerine uygun tasarlanıp üretilir.

Malzeme

- EPDM Kauçuk, 70 ± 5 Shore A Siyah
- EPDM Sünger, 0.55 gr/cm³, Siyah
- Metal Takviye

Door sealing extrusions, meeting the maximum customer expectation and the technological advancement, are designed according to the criteria as ;

- Minimum transmissibility,
- Maximum noise isolation,
- Low door-closing force,
- Vibration-free drive,
- Bridging the gaps with large tolerances,
- Easy and fast installation,

Material

- EPDM Rubber, 70 ± 5 Shore A
- EPDM Sponge Rubber, 0.55 gr/cm³, Black
- Metal Carrier



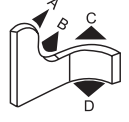

METAL TAKVİYELİ KAPI FİTİLLERİ / DOOR PROFILES WITH METAL CARRIER

Teknik Resim Technical Drawing	Kod Reference	Eski Kodu Old Ref.	Renk Color	Malzeme Material	Ambalaj Packing (mt.)	Sac Aralığı Grip Range	Bükme Radüsü Bending Radius
	A1.108	-	SİYAH BLACK	EPDM	100	1.0 - 2.0 mm	A = 50 B = 15 C = 100 D = 20
	A1.003	M111001500	SİYAH BLACK	EPDM	100	1.0 - 2.5 mm	A = 40 B = 30 C = 80 D = 40
	A1.116	-	KREM CREAM	VMQ	100	1.0 - 2.5 mm	A = 30 B = 20 C = 40 D = 140
	A1.097	-	SİYAH BLACK	EPDM	100	1.0 - 2.0 mm	A = 15 B = 15 C = 25 D = 25
	A1.099	-	SİYAH BLACK	EPDM	100	1.0 - 2.0 mm	A = 15 B = 15 C = 50 D = 30
	A1.007	M111010000	SİYAH BLACK	EPDM	100	1.0 - 2.0 mm	A = 60 B = 50 C = 80 D = 100

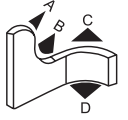

METAL TAKVİYELİ KAPI FİTİLLERİ / DOOR PROFILES WITH METAL CARRIER

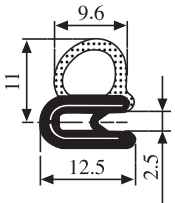
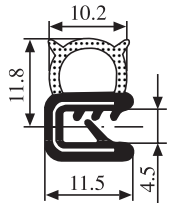
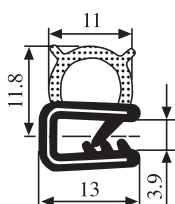
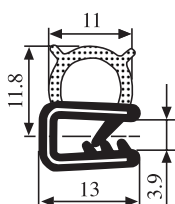
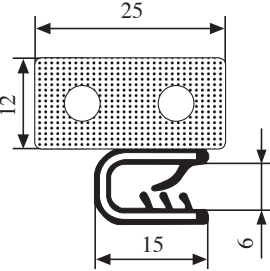
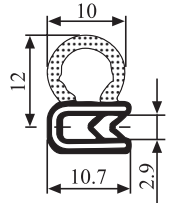
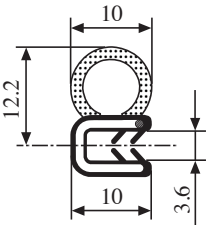
Teknik Resim Technical Drawing	Kod Reference	Eski Kodu Old Ref.	Renk Color	Malzeme Material	Ambalaj Packing (mt.)	Sac Aralığı Grip Range	Bükme Radüsü Bending Radius
	A1.001	M111000500	SİYAH BLACK	EPDM	100	1.0 - 2.0 mm	A = 30 B = 40 C = 60 D = 30
	A1.002	M111001400	SİYAH BLACK	EPDM	100	1.0 - 3.0 mm	A = 50 B = 40 C = 180 D = 80
	A1.005	M111009900	SİYAH BLACK	NBR	100	1.0 - 3.0 mm	A = 50 B = 40 C = 100 D = 80
	A1.006	M111010400	SİYAH BLACK	EPDM	100	1.0 - 3.0 mm	A = 50 B = 40 C = 100 D = 80
	A1.166	-	SİYAH BLACK	EPDM	40	3.0 - 4.0 mm	A = 130 B = 70 C = 40 D = 100
	A1.106	-	SİYAH BLACK	EPDM	100	1.0 - 2.5 mm	A = 20 B = 20 C = 50 D = 140
	A1.146	-	SİYAH BLACK	EPDM	100	1.0 - 2.0 mm	A = 30 B = 20 C = 40 D = 140

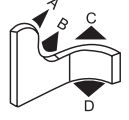

METAL TAKVİYELİ KAPI FİTİLLERİ / DOOR PROFILES WITH METAL CARRIER

Teknik Resim Technical Drawing	Kod Reference	Eski Kodu Old Ref.	Renk Color	Malzeme Material	Ambalaj Packing (mt.)	Sac Aralığı Grip Range	Bükme Radüsü Bending Radius
	A1.004	M111001600	SİYAH BLACK	EPDM	100	1.0 - 2.0 mm	A = 50 B = 40 C = - D = -
	A1.117	-	SİYAH BLACK	EPDM	100	1.0 - 3.0 mm	A = 40 B = 15 C = - D = -
	A1.010	M111012100	SİYAH BLACK	EPDM	100	1.5 - 3.0 mm	A = 80 B = 70 C = 100 D = 170
	A1.170	-	SİYAH BLACK	EPDM	100	1.0 - 2.0 mm	A = 20 B = 20 C = 90 D = 60
	A1.160	-	SİYAH BLACK	EPDM	100	1.0 - 2.0 mm	A = 40 B = 20 C = 160 D = 50

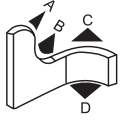

METAL TAKVİYELİ KAPI FİTİLLERİ / DOOR PROFILES WITH METAL CARRIER

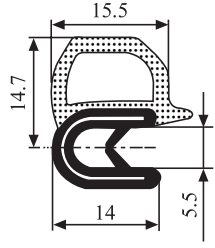
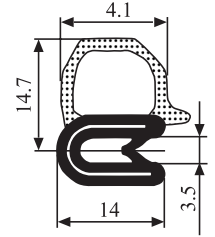
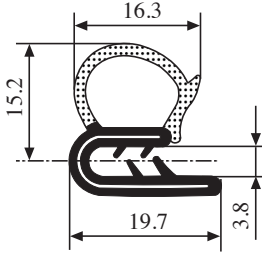
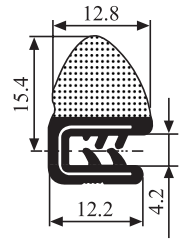
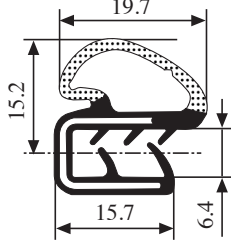
Teknik Resim Technical Drawing	Kod Reference	Eski Kodu Old Ref.	Renk Color	Malzeme Material	Ambalaj Packing (mt.)	Sac Aralığı Grip Range	Bükme Radüsü Bending Radius
	A1.011	M111003700 * Tel Takviye Wire Carrier	SİYAH BLACK	EPDM	50	1.5 - 4.0 mm	A = 60 B = 70 C = 230 D = 200
	A1.012	M111006500 * Sac Takviye Metal Carrier				1.0 - 3.5 mm	A = 40 B = 40 C = 120 D = 100
	A1.013	M111010900	SİYAH BLACK	EPDM	50	1.0 - 3.0 mm	A = 60 B = 70 C = 230 D = 200
	A1.133	-	SİYAH BLACK	EPDM	50	1.0 - 2.5 mm	A = - B = 80 C = - D = -
	A1.009	M111002700	SİYAH BLACK	EPDM	50	1.0 - 3.5 mm	A = 30 B = 30 C = 100 D = 100
	A1.152	-	SİYAH BLACK	EPDM	50	2.0 - 4.0 mm	A = - B = 70 C = 160 D = 120

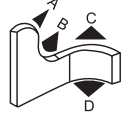

METAL TAKVİYELİ KAPI FİTİLLERİ / DOOR PROFILES WITH METAL CARRIER

Teknik Resim Technical Drawing	Kod Reference	Eski Kodu Old Ref.	Renk Color	Malzeme Material	Ambalaj Packing (mt.)	Sac Aralığı Grip Range	Bükme Radüsü Bending Radius
	A1.008	M111009700	SİYAH BLACK	EPDM	50	1.0 - 3.0 mm	A = 30 B = 25 C = 60 D = 40
	A1.014	M111011800	SİYAH BLACK	EPDM	50	1.0 - 3.0 mm	A = 60 B = 70 C = 230 D = 200
	A1.017	M111010700	SİYAH BLACK	EPDM	50	1.0 - 3.0 mm	A = 60 B = 70 C = 230 D = 200
	A1.100	-	SİYAH BLACK	EPDM	50	2.0 - 4.0 mm	A = 20 B = 20 C = 60 D = 40
	A1.015	M111004700 * Sac Takviye Metal Carrier	SİYAH BLACK	EPDM	50	1.0 - 4.0 mm	A = 40 B = 40 C = 100 D = 120
	A1.016	M111004100 * Tel Takviye Wire Carrier	SİYAH BLACK	EPDM	50	1.0 - 4.0 mm	A = 60 B = 70 C = 230 D = 190

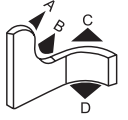

METAL TAKVİYELİ KAPI FİTİLLERİ / DOOR PROFILES WITH METAL CARRIER

Teknik Resim Technical Drawing	Kod Reference	Eski Kodu Old Ref.	Renk Color	Malzeme Material	Ambalaj Packing (mt.)	Sac Aralığı Grip Range	Bükme Radüsü Bending Radius
	A1.144	-	SİYAH BLACK	EPDM	50	1.0 - 2.5 mm	A = 70 B = 40 C = 80 D = 140
	A1.029	M111011300	SİYAH BLACK	EPDM	50	1.5 - 3.5 mm	A = 40 B = 40 C = 120 D = 150
	A1.028	M111010500	SİYAH BLACK	EPDM	50	1.0 - 3.5 mm	A = 120 B = 70 C = 130 D = 180
	A1.026	M111008300	SİYAH BLACK	EPDM	50	1.0 - 3.0 mm	A = 40 B = 40 C = 120 D = 100
	A1.044	M111011000	SİYAH BLACK	EPDM	50	3.0 - 5.0 mm	A = 70 B = 40 C = 120 D = 180

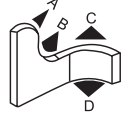

METAL TAKVİYELİ KAPI FİTİLLERİ / DOOR PROFILES WITH METAL CARRIER

Teknik Resim Technical Drawing	Kod Referance	Eski Kodu Old Ref.	Renk Color	Malzeme Material	Ambalaj Packing (mt.)	Sac Aralığı Grip Range	Bükme Radüsü Bending Radius
	A1.043	M111010600	SİYAH BLACK	EPDM	50	3.0 - 5.0 mm	A = 80 B = 50 C = 130 D = 200
	A1.032	M111007000	SİYAH BLACK	EPDM	50	1.0 - 3.5 mm	A = 60 B = 60 C = 130 D = 200
	A1.142	-	SİYAH BLACK	EPDM	50	1.5 - 3.0 mm	A = 30 B = 30 C = 60 D = 100
	A1.143	-	SİYAH BLACK	EPDM	50	1.5 - 3.0 mm	A = 30 B = 30 C = 60 D = 100
	A1.030	M111011600	SİYAH BLACK	EPDM	50	1.5 - 3.5 mm	A = 60 B = 70 C = 230 D = 200

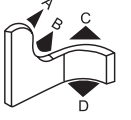

METAL TAKVİYELİ KAPI FİTİLLERİ / DOOR PROFILES WITH METAL CARRIER

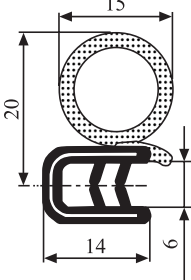
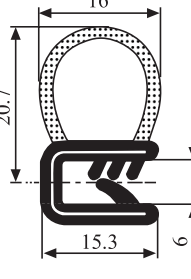
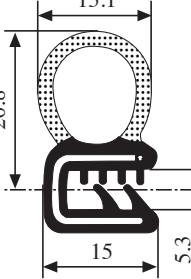
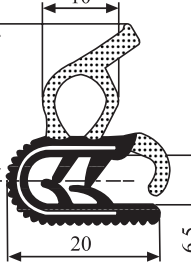
Teknik Resim Technical Drawing	Kod Reference	Eski Kodu Old Ref.	Renk Color	Malzeme Material	Ambalaj Packing (mt.)	Sac Aralığı Grip Range	Bükme Radüsü Bending Radius
	A1.018	M111004000 * Sac Takviye Metal Carrier	SİYAH BLACK	EPDM	50	1.0 - 4.0 mm	A = 40 B = 40 C = 120 D = 100
	A1.019	M111004200 * Tel Takviye Wire Carrier				1.0 - 4.0 mm	A = 60 B = 70 C = 230 D = 200
	A1.045	M111012000	SİYAH BLACK	EPDM	50	2.0 - 4.0 mm	A = 70 B = 40 C = 120 D = 180
	A1.031	M111003800	SİYAH BLACK	EPDM	50	1.5 - 4.0 mm	A = 60 B = 60 C = 120 D = 200
	A1.159	-	SİYAH BLACK	EPDM	50	2.0 - 3.0 mm	A = 130 B = 60 C = 160 D = 50
	A1.033	M111001700	SİYAH BLACK	EPDM	50	1.0 - 4.0 mm	A = - B = 40 C = 120 D = -

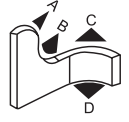

METAL TAKVİYELİ KAPI FİTİLLERİ / DOOR PROFILES WITH METAL CARRIER

Teknik Resim Technical Drawing	Kod Reference	Eski Kodu Old Ref.	Renk Color	Malzeme Material	Ambalaj Packing (mt.)	Sac Aralığı Grip Range	Bükme Radüsü Bending Radius
	A1.115	-	SİYAH BLACK	EPDM	50	3.0 - 5.0 mm	A = 80 B = 50 C = 60 D = 140
	A1.080	M111008000	SİYAH BLACK	EPDM	50	1.5 - 4.0 mm	A = 120 B = 70 C = 230 D = 200
	A1.118	-	SİYAH BLACK	EPDM	50	2.0 - 4.0 mm	A = 140 B = 50 C = 80 D = -
	A1.154	-	SİYAH BLACK	EPDM	40	4.0 - 6.0 mm	A = 40 B = 30 C = - D = -
	A1.024	M111001300	SİYAH BLACK	EPDM	50	1.0 - 4.0 mm	A = - B = 50 C = 80 D = 250

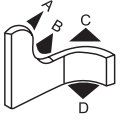

METAL TAKVİYELİ KAPI FİTİLLERİ / DOOR PROFILES WITH METAL CARRIER

Teknik Resim Technical Drawing	Kod Reference	Eski Kodu Old Ref.	Renk Color	Malzeme Material	Ambalaj Packing (mt.)	Sac Aralığı Grip Range	Bükme Radüsü Bending Radius
	A1.079	M111007900	SİYAH BLACK	EPDM	50	1.5 - 4.0 mm	A = 120 B = 80 C = 180 D = 180
	A1.023	M111001100	SİYAH BLACK	EPDM	50	1.0 - 4.0 mm	A = 60 B = 70 C = 230 D = 200
	A1.089	M111009500	SİYAH BLACK	EPDM	50	1.0 - 3.5 mm	A = 120 B = 50 C = - D = -
	A1.047	M111000400	SİYAH BLACK	EPDM	50	2.0 - 4.0 mm	A = 80 B = 60 C = 100 D = 120
	A1.027	M111006800	SİYAH BLACK	EPDM	50	2.0 - 4.0 mm	A = - B = 40 C = 120 D = 100

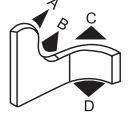

METAL TAKVİYELİ KAPI FİTİLLERİ / DOOR PROFILES WITH METAL CARRIER

Teknik Resim Technical Drawing	Kod Reference	Eski Kodu Old Ref.	Renk Color	Malzeme Material	Ambalaj Packing (mt.)	Sac Aralığı Grip Range	Bükme Radüsü Bending Radius
	A1.048	M111004500 * Sac Takviye Metal Carrier	SİYAH BLACK	EPDM	50	1.5 - 4.0 mm	A = 40 B = 40 C = - D = -
	A1.049	M111004600 * Tel Takviye Wire Carrier				1.5 - 4.0 mm	A = 60 B = 50 C = 120 D = 180
	A1.020	M111004800 * Sac Takviye Metal Carrier	SİYAH BLACK	EPDM	50	1.0 - 4.0 mm	A = 50 B = 60 C = 120 D = 100
	A1.021	M111004300 * Tel Takviye Wire Carrier				1.0 - 4.0 mm	A = 80 B = 80 C = 250 D = 230
	A1.025	M111003900	SİYAH BLACK	EPDM	50	1.5 - 4.0 mm	A = - B = 40 C = - D = -
	A1.072	M111000800	SİYAH BLACK	EPDM	40	2.0 - 5.0 mm	A = - B = 70 C = 200 D = 160
	A1.149	-	SİYAH BLACK	EPDM	50	2.0 - 4.0 mm	A = 60 B = 40 C = - D = -

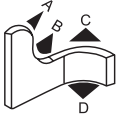

METAL TAKVİYELİ KAPI FİTİLLERİ / DOOR PROFILES WITH METAL CARRIER

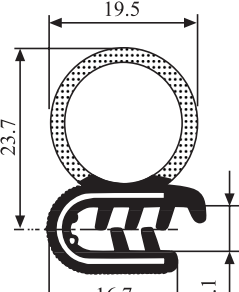
Teknik Resim Technical Drawing	Kod Reference	Eski Kodu Old Ref.	Renk Color	Malzeme Material	Ambalaj Packing (mt.)	Sac Aralığı Grip Range	Bükme Radüsü Bending Radius
	A1.050	M111005400 * Sac Takviye Metal Carrier	SİYAH BLACK	EPDM	50	1.5 - 4.0 mm	A = 40 B = 40 C = - D = -
	A1.051	M111005500 * Tel Takviye Wire Carrier				1.5 - 4.0 mm	A = 60 B = 50 C = 120 D = 180
	A1.081	M111008100	SİYAH BLACK	EPDM	50	1.5 - 4.0 mm	A = 120 B = 80 C = 140 D = 160
	A1.150	-	SİYAH BLACK	EPDM	50	2.0 - 4.0 mm	A = 140 B = 60 C = - D = 100
	A1.070	M111000600	SİYAH BLACK	EPDM	50	3.0 - 5.0 mm	A = - B = 70 C = 170 D = 220
	A1.071	M111000700	SİYAH BLACK	EPDM	50	4.0 - 6.0 mm	A = 100 B = 50 C = 130 D = 200

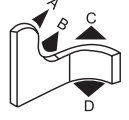

METAL TAKVİYELİ KAPI FİTİLLERİ / DOOR PROFILES WITH METAL CARRIER

Teknik Resim Technical Drawing	Kod Reference	Eski Kodu Old Ref.	Renk Color	Malzeme Material	Ambalaj Packing (mt.)	Sac Aralığı Grip Range	Bükme Radüsü Bending Radius
	A1.114	-	SİYAH BLACK	EPDM	50	2.0 - 4.0 mm	A = 100 B = 50 C = 140 D = 120
	A1.022	M111006700	SİYAH BLACK	EPDM	50	2.0 - 4.0 mm	A = 110 B = 60 C = 110 D = 160
	A1.075	M111003500 * Sac Takviye Metal Carrier	SİYAH BLACK	EPDM	50	1.5 - 4.0 mm	A = 70 B = 40 C = - D = -
	A1.076	M111003600 * Tel Takviye Wire Carrier	SİYAH BLACK	EPDM	50	1.5 - 4.0 mm	A = 120 B = 80 C = 140 D = 160
	A1.084	-	SİYAH BLACK	EPDM	50	3.0 - 5.0 mm	A = 100 B = 80 C = 200 D = -
	A1.085	M111008800	SİYAH BLACK	EPDM	50	1.0 - 3.5 mm	A = 120 B = 50 C = 160 D = 220

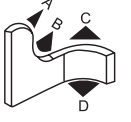

METAL TAKVİYELİ KAPI FİTİLLERİ / DOOR PROFILES WITH METAL CARRIER

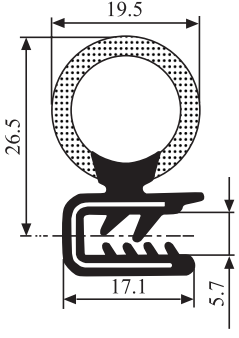
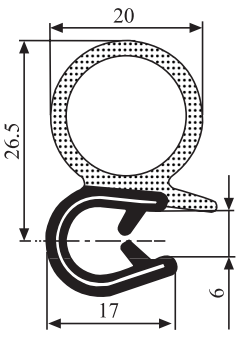
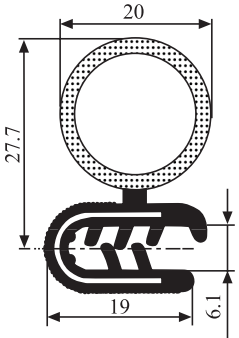
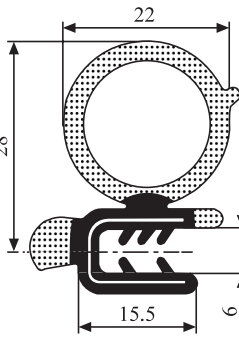
Teknik Resim Technical Drawing	Kod Reference	Eski Kodu Old Ref.	Renk Color	Malzeme Material	Ambalaj Packing (mt.)	Sac Aralığı Grip Range	Bükme Radüsü Bending Radius
	A1.083	M111011900	SİYAH BLACK	EPDM	50	2.0 - 4.0 mm	A = 120 B = 80 C = 140 D = 160
	A1.074	M111002300	SİYAH BLACK	EPDM	50	6.0 - 8.0 mm	A = 120 B = 80 C = 140 D = 160
	A1.082	M111008200	SİYAH BLACK	EPDM	50	1.5 - 4.0 mm	A = 120 B = 80 C = 140 D = 160
	A1.073	M111002000	SİYAH BLACK	EPDM	50	1.5 - 4.0 mm	A = 70 B = 70 C = 180 D = 180

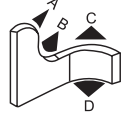

METAL TAKVİYELİ KAPI FİTİLLERİ / DOOR PROFILES WITH METAL CARRIER

Teknik Resim Technical Drawing	Kod Reference	Eski Kodu Old Ref.	Renk Color	Malzeme Material	Ambalaj Packing (mt.)	Sac Aralığı Grip Range	Bükme Radüsü Bending Radius
	A1.088	M111009400	SİYAH BLACK	EPDM	50	1.0 - 4.0 mm	A = 100 B = 50 C = - D = -
	A1.139	-	SİYAH BLACK	EPDM	50	2.0 - 4.0 mm	A = 90 B = 80 C = - D = -
	A1.140	-	SİYAH BLACK	EPDM	50	3.0 - 5.0 mm	A = 90 B = 80 C = - D = -
	A1.107	-	SİYAH BLACK	EPDM	50	1.0 - 3.0 mm	A = 140 B = 20 C = - D = -

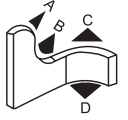

METAL TAKVİYELİ KAPI FİTİLLERİ / DOOR PROFILES WITH METAL CARRIER

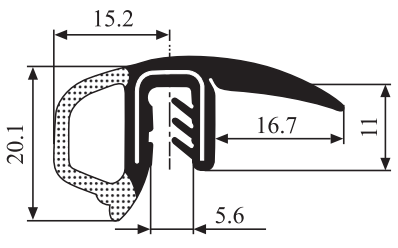
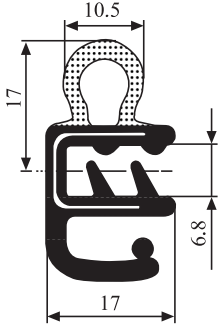
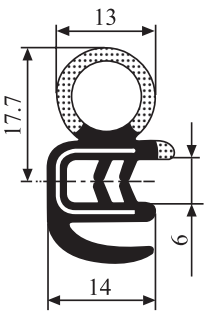
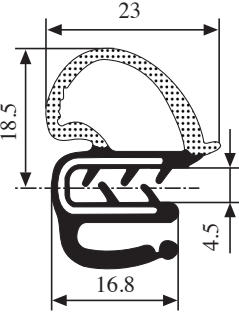
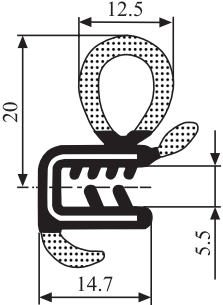
Teknik Resim Technical Drawing	Kod Reference	Eski Kodu Old Ref.	Renk Color	Malzeme Material	Ambalaj Packing (mt.)	Sac Aralığı Grip Range	Bükme Radüsü Bending Radius
	A1.091	-	SİYAH BLACK	EPDM	40	4.0 - 5.0 mm	A = - B = - C = - D = -
	A1.052	M111000900	SİYAH BLACK	EPDM	50	2.0 - 4.0 mm	A = - B = 60 C = - D = 200
	A1.127	-	SİYAH BLACK	EPDM	50	1.5 - 4.0 mm	A = 140 B = 50 C = - D = -
	A1.151	-	SİYAH BLACK	EPDM	50	2.0 - 3.0 mm	A = - B = 130 C = 130 D = -
	A1.053	M111010100	SİYAH BLACK	EPDM	50	1.5 - 3.5 mm	A = 120 B = 50 C = 150 D = 150

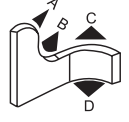

METAL TAKVİYELİ KAPI FİTİLLERİ / DOOR PROFILES WITH METAL CARRIER

Teknik Resim Technical Drawing	Kod Reference	Eski Kodu Old Ref.	Renk Color	Malzeme Material	Ambalaj Packing (mt.)	Sac Aralığı Grip Range	Bükme Radüsü Bending Radius
	A1.096	-	SİYAH BLACK	EPDM	50	1.5 - 4.0 mm	A = - B = 60 C = 230 D = -
	A1.128	-	SİYAH BLACK	EPDM	50	1.5 - 4.0 mm	A = 140 B = 50 C = - D = -
	A1.055	M111005000 * Tel Takviye Wire Carrier	SİYAH BLACK	EPDM	50	1.5 - 4.0 mm	A = - B = 70 C = - D = 220
	A1.056	M111005100 * Sac Takviye Metal Carrier	SİYAH BLACK	EPDM	50	1.5 - 4.0 mm	A = - B = 40 C = - D = -
	A1.054	M111010200	SİYAH BLACK	EPDM	50	2.5 - 5.0 mm	A = 120 B = 40 C = - D = -
	A1.057	M111008700	SİYAH BLACK	EPDM	40	1.0 - 3.5 mm	A = - B = 50 C = 180 D = 170

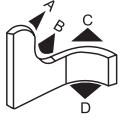

METAL TAKVİYELİ KAPI FİTİLLERİ / DOOR PROFILES WITH METAL CARRIER

Teknik Resim Technical Drawing	Kod Reference	Eski Kodu Old Ref.	Renk Color	Malzeme Material	Ambalaj Packing (mt.)	Sac Aralığı Grip Range	Bükme Radüsü Bending Radius
	A1.156	-	SİYAH BLACK	EPDM	40	5.0 - 6.0 mm	A = - B = 30 C = - D = -
	A1.113	-	SİYAH BLACK	EPDM	40	2.0 - 5.0 mm	A = - B = 70 C = 160 D = 200
	A1.125	-	SİYAH BLACK	EPDM	50	1.5 - 4.0 mm	A = - B = 70 C = - D = 220
	A1.132	-	SİYAH BLACK	EPDM	50	4.0 - 6.0 mm	A = 50 B = 60 C = - D = -

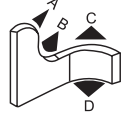

METAL TAKVİYELİ KAPI FİTİLLERİ / DOOR PROFILES WITH METAL CARRIER

Teknik Resim Technical Drawing	Kod Reference	Eski Kodu Old Ref.	Renk Color	Malzeme Material	Ambalaj Packing (mt.)	Sac Aralığı Grip Range	Bükme Radüsü Bending Radius
	A1.034	M111000100	SİYAH BLACK	EPDM	50	4.0 - 6.0 mm	A = 70 B = 70 C = - D = -
	A1.169	-	SİYAH BLACK	EPDM	50	4.0 - 6.0 mm	A = 50 B = 50 C = - D = -
	A1.098	-	SİYAH BLACK	EPDM	50	1.5 - 4.0 mm	A = 25 B = 25 C = 60 D = 70
	A1.147	-	SİYAH BLACK	EPDM	50	4.0 - 5.0 mm	A = 30 B = 20 C = 150 D = 80
	A1.039	M111005850	SİYAH BLACK	EPDM	50	2.0 - 5.0 mm	A = 50 B = 50 C = - D = -

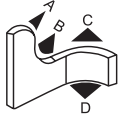

METAL TAKVİYELİ KAPI FİTİLLERİ / DOOR PROFILES WITH METAL CARRIER

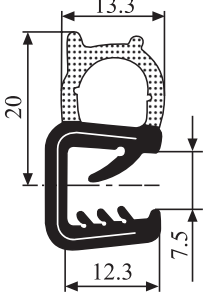
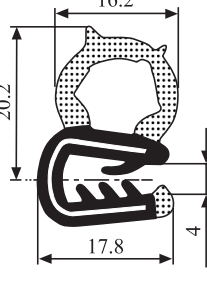
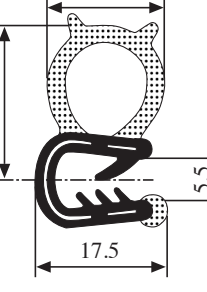
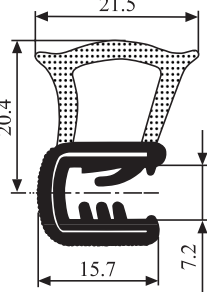
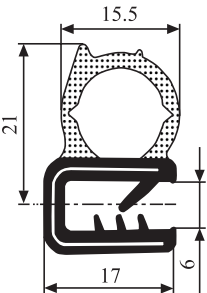
Teknik Resim Technical Drawing	Kod Reference	Eski Kodu Old Ref.	Renk Color	Malzeme Material	Ambalaj Packing (mt.)	Sac Aralığı Grip Range	Bükme Radüsü Bending Radius
	A1.094	-	SİYAH BLACK	EPDM	50	5.0 - 8.0 mm	A = 25 B = 25 C = - D = -
	A1.042	M111011100	SİYAH BLACK	EPDM	50	3.0 - 5.0 mm	A = 60 B = 20 C = 100 D = 120
	A1.148	-	SİYAH BLACK	EPDM	50	2.0 - 5.0 mm	A = 50 B = 20 C = 160 D = 70
	A1.040	M111009600	SİYAH BLACK	EPDM	50	3.0 - 5.0 mm	A = 60 B = 60 C = - D = -
	A1.037	M111005200	SİYAH BLACK	EPDM	50	2.0 - 4.0 mm	A = 70 B = 40 C = 120 D = 180

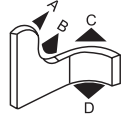

METAL TAKVİYELİ KAPI FİTİLLERİ / DOOR PROFILES WITH METAL CARRIER

Teknik Resim Technical Drawing	Kod Reference	Eski Kodu Old Ref.	Renk Color	Malzeme Material	Ambalaj Packing (mt.)	Sac Aralığı Grip Range	Bükme Radüsü Bending Radius
	A1.038	M111006200	SİYAH BLACK	EPDM	50	3.0 - 5.0 mm	A = 80 B = 50 C = 130 D = 200
	A1.036	M111000300	SİYAH BLACK	EPDM	50	3.0 - 5.0 mm	A = 80 B = 80 C = - D = -
	A1.041	M111010800	SİYAH BLACK	EPDM	50	4.0 - 6.0 mm	A = 40 B = 25 C = - D = -
	A1.101	-	SİYAH BLACK	EPDM	50	3.0 - 6.0 mm	A = 25 B = 25 C = 60 D = 70
	A1.035	M111000200	SİYAH BLACK	EPDM	50	2.0 - 4.0 mm	A = 60 B = 50 C = 80 D = 100

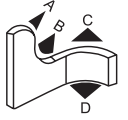

METAL TAKVİYELİ KAPI FİTİLLERİ / DOOR PROFILES WITH METAL CARRIER

Teknik Resim Technical Drawing	Kod Reference	Eski Kodu Old Ref.	Renk Color	Malzeme Material	Ambalaj Packing (mt.)	Sac Aralığı Grip Range	Bükme Radüsü Bending Radius
	A1.141	-	SİYAH BLACK	EPDM	50	2.0 - 5.0 mm	A = 60 B = 140 C = - D = -
	A1.046	M111005300	SİYAH BLACK	EPDM	50	1.5 - 4.0 mm	A = 40 B = 40 C = - D = -
	A1.109	-	SİYAH BLACK	EPDM	50	3.0 - 5.0 mm	A = 60 B = 60 C = - D = -
	A1.165	-	SİYAH BLACK	EPDM	50	2.0 - 3.0 mm	A = 30 B = 20 C = - D = 90
	A1.058	M112003000	SİYAH BLACK	EPDM	50	1.0 - 4.0 mm	A = 40 B = 30 C = 40 D = 150

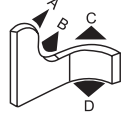

METAL TAKVİYELİ KAPI FİTİLLERİ / DOOR PROFILES WITH METAL CARRIER

Teknik Resim Technical Drawing	Kod Reference	Eski Kodu Old Ref.	Renk Color	Malzeme Material	Ambalaj Packing (mt.)	Sac Aralığı Grip Range	Bükme Radüsü Bending Radius
	A1.120	-	SİYAH BLACK	EPDM	50	2.0 - 3.0 mm	A = 140 B = 130 C = 50 D = -
	A1.167	-	SİYAH BLACK	EPDM	50	3.0 - 5.0 mm	A = 20 B = 20 C = - D = -
	A1.173	-	SİYAH BLACK	EPDM	50	3.0 - 5.0 mm	A = 20 B = 20 C = - D = -
	A1.059	M111006100	SİYAH BLACK	EPDM	50	1.5 - 4.0 mm	A = 50 B = 50 C = - D = -
	A1.060	M111009100	SİYAH BLACK	EPDM	50	1.5 - 3.5 mm	A = 90 B = 60 C = 200 D = 250

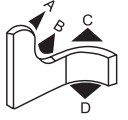

METAL TAKVİYELİ KAPI FİTİLLERİ / DOOR PROFILES WITH METAL CARRIER

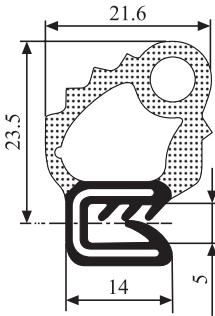
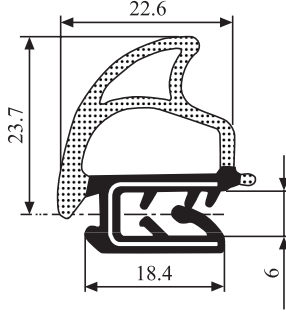
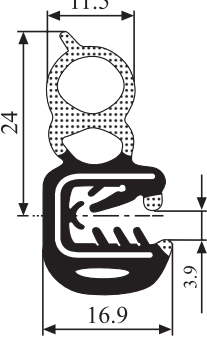
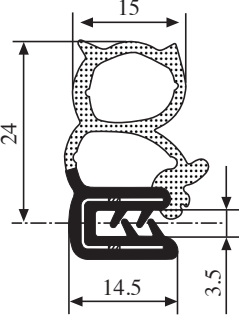
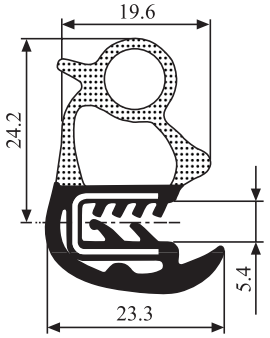
Teknik Resim Technical Drawing	Kod Reference	Eski Kodu Old Ref.	Renk Color	Malzeme Material	Ambalaj Packing (mt.)	Sac Aralığı Grip Range	Bükme Radüsü Bending Radius
	A1.121	-	SİYAH BLACK	EPDM	50	1.0 - 3.0 mm	A = 140 B = 110 C = 140 D = 50
	A1.064	M111011500	SİYAH BLACK	EPDM	50	2.0 - 4.0 mm	A = 80 B = 40 C = - D = -
	A1.093	-	SİYAH BLACK	EPDM	50	2.0 - 5.0 mm	A = 20 B = 20 C = - D = -
	A1.104	-	SİYAH BLACK	EPDM	50	1.0 - 2.5 mm	A = 110 B = 70 C = - D = -
	A1.063	M111008500	SİYAH BLACK	EPDM	50	1.5 - 3.5 mm	A = 180 B = 80 C = 160 D = 180

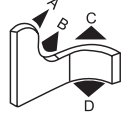

METAL TAKVİYELİ KAPI FİTİLLERİ / DOOR PROFILES WITH METAL CARRIER

Teknik Resim Technical Drawing	Kod Reference	Eski Kodu Old Ref.	Renk Color	Malzeme Material	Ambalaj Packing (mt.)	Sac Aralığı Grip Range	Bükme Radüsü Bending Radius
	A1.077	M111006600	SİYAH BLACK	EPDM	50	6.0 - 8.0 mm	A = - B = 40 C = 150 D = 120
	A1.078	M111009300	SİYAH BLACK	EPDM	50	6.0 - 8.0 mm	A = - B = 40 C = 150 D = 120
	A1.069	M111010300	SİYAH BLACK	EPDM	50	4.0 - 6.0 mm	A = 30 B = 30 C = - D = -
	A1.087	M111009000	SİYAH BLACK	EPDM	50	2.0 - 4.0 mm	A = 70 B = 50 C = - D = -

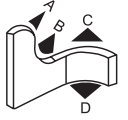

METAL TAKVİYELİ KAPI FİTİLLERİ / DOOR PROFILES WITH METAL CARRIER

Teknik Resim Technical Drawing	Kod Reference	Eski Kodu Old Ref.	Renk Color	Malzeme Material	Ambalaj Packing (mt.)	Sac Aralığı Grip Range	Bükme Radüsü Bending Radius
	A1.145	-	SİYAH BLACK	EPDM	50	4.0 - 5.0 mm	A = 110 B = 70 C = 110 D = -
	A1.065	M111012300	SİYAH BLACK	EPDM	50	2.0 - 4.0 mm	A = 60 B = 30 C = 80 D = 200
	A1.092	-	SİYAH BLACK	EPDM	40	1.5 - 4.0 mm	A = 50 B = - C = - D = -
	A1.086	M111008900	SİYAH BLACK	EPDM	50	1.0 - 4.0 mm	A = - B = 50 C = 120 D = 250

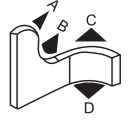

METAL TAKVİYELİ KAPI FİTİLLERİ / DOOR PROFILES WITH METAL CARRIER

Teknik Resim Technical Drawing	Kod Reference	Eski Kodu Old Ref.	Renk Color	Malzeme Material	Ambalaj Packing (mt.)	Sac Aralığı Grip Range	Bükme Radüsü Bending Radius
	A1.061	-	SİYAH BLACK	EPDM	50	2.0 - 4.0 mm	A = 80 B = 40 C = - D = -
	A1.068	M111009200	SİYAH BLACK	EPDM	50	2.0 - 4.0 mm	A = 50 B = 40 C = - D = -
	A1.172	-	SİYAH BLACK	EPDM	40	1.0 - 3.0 mm	A = 50 B = 40 C = - D = -
	A1.171	-	SİYAH BLACK	EPDM	40	2.0 - 3.0 mm	A = - B = 40 C = 120 D = -

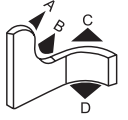

METAL TAKVİYELİ KAPI FİTİLLERİ / DOOR PROFILES WITH METAL CARRIER

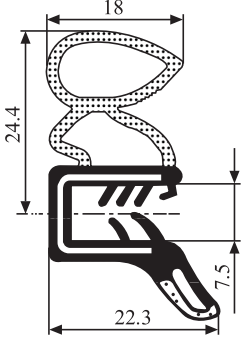
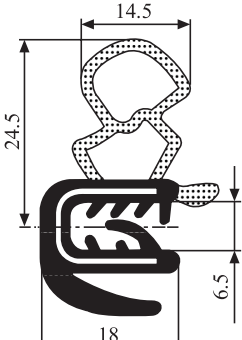
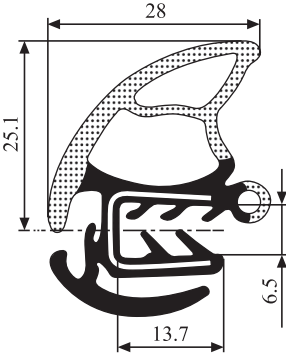
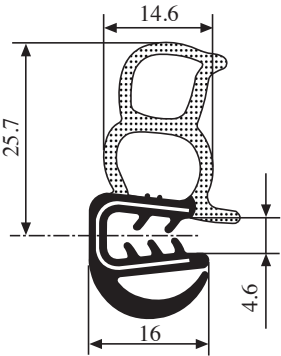
Teknik Resim Technical Drawing	Kod Reference	Eski Kodu Old Ref.	Renk Color	Malzeme Material	Ambalaj Packing (mt.)	Sac Aralığı Grip Range	Bükme Radüsü Bending Radius
	A1.066	M111002200	SİYAH BLACK	EPDM	50	1.5 - 4.0 mm	A = - B = 50 C = 180 D = 180
	A1.067	M111007400	SİYAH BLACK	EPDM	50	1.5 - 4.0 mm	A = - B = 60 C = 300 D = 300
	A1.129	-	SİYAH BLACK	EPDM	40	3.0 - 6.0 mm	A = - B = 50 C = - D = -
	A1.130	-	SİYAH BLACK	EPDM	40	2.0 - 4.0 mm	A = - B = 60 C = 140 D = -

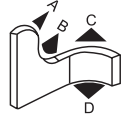

METAL TAKVİYELİ KAPI FİTİLLERİ / DOOR PROFILES WITH METAL CARRIER

Teknik Resim Technical Drawing	Kod Reference	Eski Kodu Old Ref.	Renk Color	Malzeme Material	Ambalaj Packing (mt.)	Sac Aralığı Grip Range	Bükme Radüsü Bending Radius
	A1.062	M111009800	SİYAH BLACK	EPDM	50	1.5 - 3.0 mm	A = 150 B = 150 C = - D = 160
	A1.135	-	SİYAH BLACK	EPDM	40	3.0 - 5.0 mm	A = 120 B = 80 C = - D = -
	A1.136	-	SİYAH BLACK	EPDM	40	3.0 - 5.0 mm	A = 100 B = 60 C = 140 D = -
	A1.126	-	SİYAH BLACK	EPDM	40	3.0 - 6.0 mm	A = 140 B = 100 C = - D = -

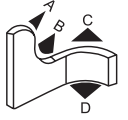

METAL TAKVİYELİ KAPI FİTİLLERİ / DOOR PROFILES WITH METAL CARRIER

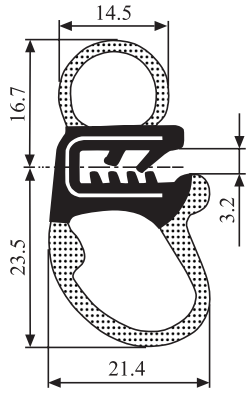
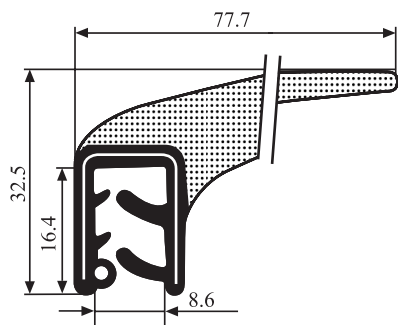
Teknik Resim Technical Drawing	Kod Reference	Eski Kodu Old Ref.	Renk Color	Malzeme Material	Ambalaj Packing (mt.)	Sac Aralığı Grip Range	Bükme Radüsü Bending Radius
	A1.090	M111008600	SİYAH BLACK	EPDM	50	1.5 - 3.0 mm	A = 120 B = 40 C = - D = -
	A1.122	-	SİYAH BLACK	EPDM	20	3.0 - 7.0 mm	A = 140 B = 40 C = - D = -



METAL TAKVİYELİ BAGAJ PROFİLLERİ REAR-LID PROFILES WITH METAL CARRIER

Bagaj sızdırmazlık fitilleri günümüz teknolojik gelişme ve maksimum müşteri beklentilerine paralel olarak;

- Minimum geçirgenlik,
- Maksimum ses izolasyonu,
- Düşük kapanma kuvveti,
- Titreşimsiz sürüş,
- Geniş toleranslı boşlukları kapatabilme,
- Kolay ve hızlı montaj,

özelliklerine uygun tasarlanıp üretilir.

Malzeme

- EPDM Kauçuk, 70 ± 5 Shore A Siyah
- EPDM Sünger, 0.55 gr/cm³, Siyah
- Metal Takviye

Rear-lid sealing extrusions, meeting the maximum customer expectation and the technological advancement, are designed according to the criteria as ;

- Minimum transmissibility,
- Maximum noise isolation,
- Low door-closing force,
- Vibration-free drive,
- Bridging the gaps with large tolerances,
- Easy and fast installation,

Material

- EPDM Rubber, 70 ± 5 Shore A
- EPDM Sponge Rubber, 0.55 gr/cm³, Black
- Metal Carrier



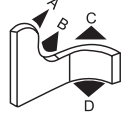

METAL TAKVİYELİ BAGAJ FİTİLLERİ / REAR-LID PROFILES WITH METAL CARRIER

Teknik Resim Technical Drawing	Kod Reference	Eski Kodu Old Ref.	Renk Color	Malzeme Material	Ambalaj Packing (mt.)	Sac Aralığı Grip Range	Bükme Radüsü Bending Radius
	A2.003	M112002600	SİYAH BLACK	EPDM	100	1.0 - 2.0 mm	A = 50 B = 60 C = 20 D = 20
	A2.075	-	SİYAH BLACK	UL94-V0	100	1.0 - 2.0 mm	A = 50 B = 60 C = 20 D = 20
	A2.064	-	SİYAH BLACK	EPDM	100	1.5 - 2.0 mm	A = 30 B = 50 C = 20 D = 20
	A2.002	M112004100	SİYAH BLACK	EPDM	100	1.0 - 1.5 mm	A = 50 B = 80 C = 20 D = 20
	A2.005	M112001200	SİYAH BLACK	EPDM	100	1.0 - 3.5 mm	A = 50 B = 90 C = 30 D = 30

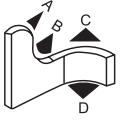

METAL TAKVİYELİ BAGAJ FİTİLLERİ / REAR-LID PROFILES WITH METAL CARRIER

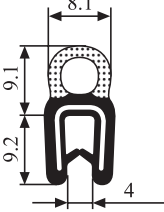
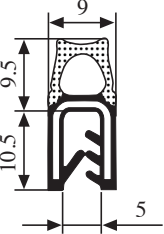
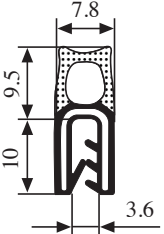
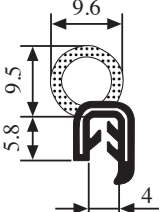
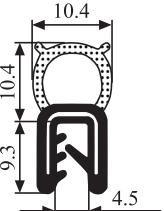
Teknik Resim Technical Drawing	Kod Reference	Eski Kodu Old Ref.	Renk Color	Malzeme Material	Ambalaj Packing (mt.)	Sac Aralığı Grip Range	Bükme Radüsü Bending Radius
	A2.053	-	SİYAH BLACK	EPDM	100	1.0 - 3.0 mm	A = 30 B = 70 C = 15 D = 15
	A2.074	-	SİYAH BLACK	EPDM	100	2.0 - 4.0 mm	A = 160 B = 160 C = 20 D = 20
	A2.077	-	SİYAH BLACK	EPDM	100	1.0 - 2.0 mm	A = 160 B = 160 C = 20 D = 20
	A2.070	-	SİYAH BLACK	EPDM	100	2.0 - 2.5 mm	A = 130 B = 50 C = 20 D = 40
	A2.004	M112001100	SİYAH BLACK	EPDM	100	1.0 - 3.0 mm	A = 50 B = 100 C = 30 D = 30

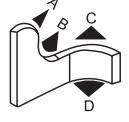

METAL TAKVİYELİ BAGAJ FİTİLLERİ / REAR-LID PROFILES WITH METAL CARRIER

Teknik Resim Technical Drawing	Kod Reference	Eski Kodu Old Ref.	Renk Color	Malzeme Material	Ambalaj Packing (mt.)	Sac Aralığı Grip Range	Bükme Radüsü Bending Radius
	A2.006 A2.007	M112003700 M112004200	SİYAH BLACK	NBR EPDM	100 100	1.0 - 3.5 mm	A = 50 B = 90 C = 30 D = 30
	A2.008	M112003400	SİYAH BLACK	EPDM	100	3.0 - 5.0 mm	A = 50 B = 180 C = 30 D = 30
	A2.072	-	SİYAH BLACK	EPDM	100	1.5 - 2.0 mm	A = 140 B = 60 C = 20 D = 20
	A2.001	M112000200	SİYAH BLACK	EPDM	100	1.0 - 3.0 mm	A = 60 B = 120 C = 25 D = 25
	A2.069	-	SİYAH BLACK	EPDM	100	2.0 - 3.0 mm	A = 160 B = 160 C = 20 D = 30

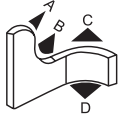

METAL TAKVİYELİ BAGAJ FİTİLLERİ / REAR-LID PROFILES WITH METAL CARRIER

Teknik Resim Technical Drawing	Kod Reference	Eski Kodu Old Ref.	Renk Color	Malzeme Material	Ambalaj Packing (mt.)	Sac Aralığı Grip Range	Bükme Radüsü Bending Radius
	A2.062	-	SİYAH BLACK	EPDM	100	4.0 - 6.0 mm	A = 70 B = 120 C = 30 D = 30
	A2.009	M112001250	SİYAH BLACK	EPDM	100	1.0 - 3.5 mm	A = 80 B = 200 C = 40 D = 30
	A2.022	M112004300	SİYAH BLACK	EPDM	50	1.0 - 3.0 mm	A = 80 B = 250 C = 40 D = 30
	A2.038	M112003100	SİYAH BLACK	EPDM	50	1.0 - 4.0 mm	A = 70 B = 120 C = 30 D = 30
	A2.047	-	SİYAH BLACK	EPDM	50	1.0 - 3.0 mm	A = 110 B = 110 C = 30 D = 30

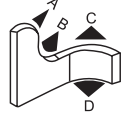

METAL TAKVİYELİ BAGAJ FİTİLLERİ / REAR-LID PROFILES WITH METAL CARRIER

Teknik Resim Technical Drawing	Kod Reference	Eski Kodu Old Ref.	Renk Color	Malzeme Material	Ambalaj Packing (mt.)	Sac Aralığı Grip Range	Bükme Radüsü Bending Radius
	A2.071	-	SİYAH BLACK	EPDM	50	3.0 - 5.0 mm	A = 120 B = 160 C = 30 D = 30
	A2.012	M112002100	SİYAH BLACK	EPDM	50	1.5 - 4.0 mm	A = 100 B = 150 C = 50 D = 50
	A2.065	-	SİYAH BLACK	EPDM	50	2.5 - 4.0 mm	A = 140 B = 120 C = 20 D = 20
	A2.027	M112002700	SİYAH BLACK	EPDM	50	1.5 - 4.0 mm	A = 100 B = 200 C = 60 D = 100

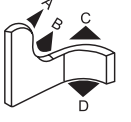

METAL TAKVİYELİ BAGAJ FİTİLLERİ / REAR-LID PROFILES WITH METAL CARRIER

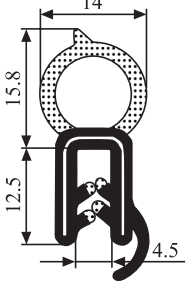
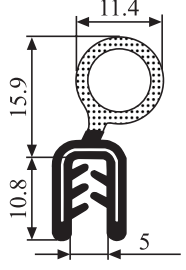
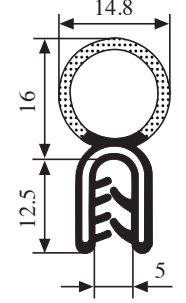
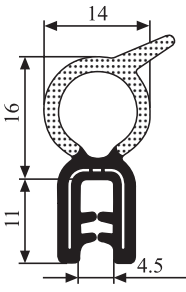
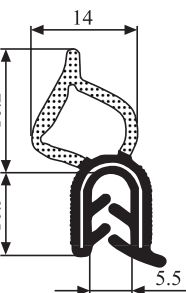
Teknik Resim Technical Drawing	Kod Reference	Eski Kodu Old Ref.	Renk Color	Malzeme Material	Ambalaj Packing (mt.)	Sac Aralığı Grip Range	Bükme Radüsü Bending Radius
	A2.016	M112000700	SİYAH BLACK	EPDM	50	1.0 - 3.5 mm	A = 100 B = 150 C = 50 D = 50
	A2.019	M112003500	SİYAH BLACK	EPDM	50	1.5 - 4.0 mm	A = 120 B = 200 C = - D = 150
	A2.073	-	SİYAH BLACK	EPDM	50	1.0 - 3.0 mm	A = 160 B = - C = 60 D = 60
	A2.050	-	SİYAH BLACK	EPDM	50	1.0 - 4.0 mm	A = 80 B = 120 C = 60 D = 140
	A2.026	M112002500	SİYAH BLACK	EPDM	50	1.5 - 4.0 mm	A = 100 B = 200 C = 60 D = 100

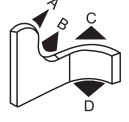

METAL TAKVİYELİ BAGAJ FİTİLLERİ / REAR-LID PROFILES WITH METAL CARRIER

Teknik Resim Technical Drawing	Kod Reference	Eski Kodu Old Ref.	Renk Color	Malzeme Material	Ambalaj Packing (mt.)	Sac Aralığı Grip Range	Bükme Radüsü Bending Radius
	A2.024	M112000800 * Sac Takviye Metal Carrier	SİYAH BLACK	EPDM	50	1.0 - 3.5 mm	A = 100 B = 150 C = 50 D = 50
	A2.025	M112000850 * Tel Takviye Wire Carrier					A = 80 B = 250 C = 40 D = 30
	A2.081	-	SİYAH BLACK	EPDM	50	2.0 - 4.0 mm	A = 120 B = 120 C = 40 D = 40
	A2.021	M112004400	SİYAH BLACK	EPDM	50	1.5 - 4.0 mm	A = 100 B = 150 C = 50 D = 50
	A2.010	M112004700	SİYAH BLACK	EPDM	50	2.0 - 4.0 mm	A = 50 B = - C = 40 D = 80
	A2.011	M112003800	SİYAH BLACK	EPDM	50	1.0 - 3.0 mm	A = 100 B = 200 C = 60 D = 100

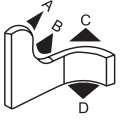

METAL TAKVİYELİ BAGAJ FİTİLLERİ / REAR-LID PROFILES WITH METAL CARRIER

Teknik Resim Technical Drawing	Kod Reference	Eski Kodu Old Ref.	Renk Color	Malzeme Material	Ambalaj Packing (mt.)	Sac Aralığı Grip Range	Bükme Radüsü Bending Radius
	A2.056	-	SİYAH BLACK	EPDM	50	1.0 - 1.5 mm	A = 90 B = 140 C = 30 D = 30
	A2.017	M112001900	SİYAH BLACK	EPDM	50	1.5 - 4.0 mm	A = 110 B = 150 C = 50 D = 50
	A2.043	-	SİYAH BLACK	EPDM	50	1.5 - 3.5 mm	A = 30 B = 50 C = 30 D = 30
	A2.061	-	SİYAH BLACK	EPDM	50	1.5 - 3.0 mm	A = 80 B = 130 C = 40 D = 40
	A2.067	-	SİYAH BLACK	EPDM	50	2.0 - 4.0 mm	A = 160 B = - C = 20 D = 20

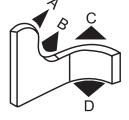

METAL TAKVİYELİ BAGAJ FİTİLLERİ / REAR-LID PROFILES WITH METAL CARRIER

Teknik Resim Technical Drawing	Kod Reference	Eski Kodu Old Ref.	Renk Color	Malzeme Material	Ambalaj Packing (mt.)	Sac Aralığı Grip Range	Bükme Radüsü Bending Radius
	A2.033	M112002300	SİYAH BLACK	EPDM	50	2.0 - 4.0 mm	A = 130 B = 100 C = 40 D = 40
	A2.018	M112002000	SİYAH BLACK	EPDM	50	1.5 - 4.0 mm	A = 120 B = 160 C = 60 D = 60
	A2.028	M112001300	SİYAH BLACK	EPDM	50	1.0 - 4.0 mm	A = 100 B = 180 C = 50 D = 50
	A2.052	-	SİYAH BLACK	EPDM	50	1.0 - 3.0 mm	A = 80 B = 180 C = 40 D = 40
	A2.058	-	SİYAH BLACK	EPDM	50	2.5 - 4.0 mm	A = - B = - C = 90 D = 90

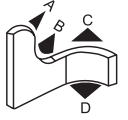

METAL TAKVİYELİ BAGAJ FİTİLLERİ / REAR-LID PROFILES WITH METAL CARRIER

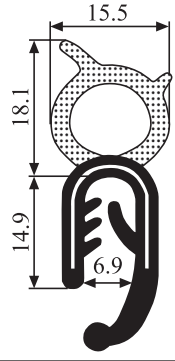
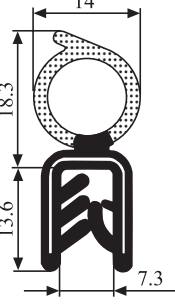
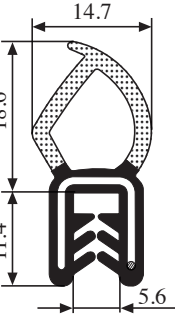
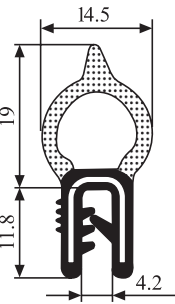
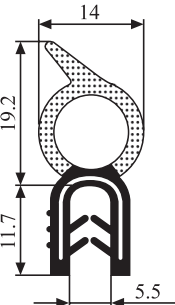
Teknik Resim Technical Drawing	Kod Reference	Eski Kodu Old Ref.	Renk Color	Malzeme Material	Ambalaj Packing (mt.)	Sac Aralığı Grip Range	Bükme Radüsü Bending Radius
	A2.034	M112003600	SİYAH BLACK	EPDM	50	2.0 - 4.0 mm	A = - B = 160 C = 50 D = 50
	A2.030	M112001800	SİYAH BLACK	EPDM	50	1.5 - 5.0 mm	A = 130 B = 100 C = 40 D = 40
	A2.066	-	SİYAH BLACK	EPDM	50	1.0 - 4.0 mm	A = 110 B = - C = 40 D = 40
	A2.023	M112000100	SİYAH BLACK	EPDM	50	1.0 - 3.5 mm	A = 100 B = 250 C = 50 D = 40
	A2.039	-	SİYAH BLACK	EPDM	50	2.0 - 4.0 mm	A = 50 B = - C = 40 D = 40

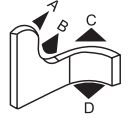

METAL TAKVİYELİ BAGAJ FİTİLLERİ / REAR-LID PROFILES WITH METAL CARRIER

Teknik Resim Technical Drawing	Kod Reference	Eski Kodu Old Ref.	Renk Color	Malzeme Material	Ambalaj Packing (mt.)	Sac Aralığı Grip Range	Bükme Radüsü Bending Radius
	A2.013	M112000400	SİYAH BLACK	EPDM	50	1.0 - 3.5 mm	A = 100 B = 140 C = 50 D = 50
	A2.046	-	SİYAH BLACK	EPDM	50	1.5 - 3.5 mm	A = 25 B = 40 C = 10 D = 10
	A2.049	-	SİYAH BLACK	EPDM	50	1.0 - 3.0 mm	A = 180 B = - C = 60 D = -
	A2.040	-	SİYAH BLACK	EPDM	40	1.5 - 3.0 mm	A = 25 B = 60 C = 60 D = 60

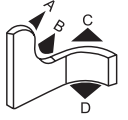

METAL TAKVİYELİ BAGAJ FİTİLLERİ / REAR-LID PROFILES WITH METAL CARRIER

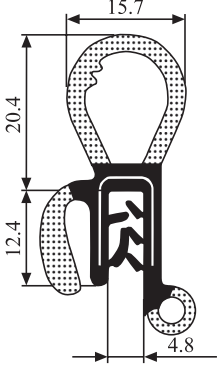
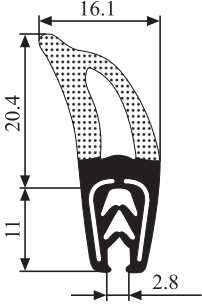
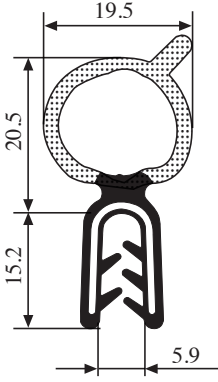
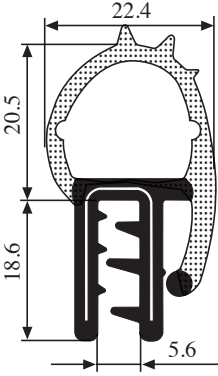
Teknik Resim Technical Drawing	Kod Reference	Eski Kodu Old Ref.	Renk Color	Malzeme Material	Ambalaj Packing (mt.)	Sac Aralığı Grip Range	Bükme Radüsü Bending Radius
	A2.029	M112002800	SİYAH BLACK	EPDM	50	1.5 - 4.0 mm	A = - B = 150 C = 80 D = 100
	A2.041	-	SİYAH BLACK	EPDM	50	1.5 - 3.0 mm	A = 50 B = - C = 15 D = 15
	A2.055	-	SİYAH BLACK	EPDM	50	1.5 - 3.0 mm	A = 130 B = - C = 100 D = 40
	A2.059	-	SİYAH BLACK	EPDM	40	2.5 - 4.0 mm	A = - B = - C = 120 D = 80

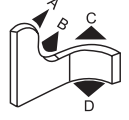

METAL TAKVİYELİ BAGAJ FİTİLLERİ / REAR-LID PROFILES WITH METAL CARRIER

Teknik Resim Technical Drawing	Kod Reference	Eski Kodu Old Ref.	Renk Color	Malzeme Material	Ambalaj Packing (mt.)	Sac Aralığı Grip Range	Bükme Radüsü Bending Radius
	A2.060	-	SİYAH BLACK	EPDM	40	3.0 - 5.0 mm	A = - B = - C = 120 D = 120
	A2.036	M112002400	SİYAH BLACK	EPDM	40	2.0 - 4.0 mm	A = 130 B = 110 C = 40 D = 50
	A2.048	-	SİYAH BLACK	EPDM	50	1.0 - 3.0 mm	A = 80 B = 150 C = 50 D = 50
	A2.032	M112002900	SİYAH BLACK	EPDM	50	1.5 - 4.0 mm	A = 100 B = 120 C = 40 D = 40

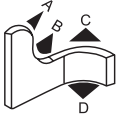

METAL TAKVİYELİ BAGAJ FİTİLLERİ / REAR-LID PROFILES WITH METAL CARRIER

Teknik Resim Technical Drawing	Kod Reference	Eski Kodu Old Ref.	Renk Color	Malzeme Material	Ambalaj Packing (mt.)	Sac Aralığı Grip Range	Bükme Radüsü Bending Radius
	A2.020	M112004600	SİYAH BLACK	EPDM	50	2.0 - 4.0 mm	A = 120 B = 200 C = 50 D = 50
	A2.068	-	SİYAH BLACK	EPDM	40	3.0 - 5.0 mm	A = - B = 140 C = 80 D = 80
	A2.014	M112000500	SİYAH BLACK	EPDM	50	1.0 - 3.5 mm	A = 110 B = 150 C = 50 D = 50
	A2.031	M112001700	SİYAH BLACK	EPDM	50	1.5 - 5.0 mm	A = 150 B = 100 C = 40 D = 50

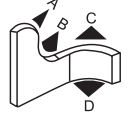

METAL TAKVİYELİ BAGAJ FİTİLLERİ / REAR-LID PROFILES WITH METAL CARRIER

Teknik Resim Technical Drawing	Kod Reference	Eski Kodu Old Ref.	Renk Color	Malzeme Material	Ambalaj Packing (mt.)	Sac Aralığı Grip Range	Bükme Radüsü Bending Radius
	A2.037	M112004500	SİYAH BLACK	EPDM	50	2.5 - 5.0 mm	A = 150 B = 200 C = 70 D = 70
	A2.044	-	SİYAH BLACK	EPDM	40	2.0 - 3.0 mm	A = 60 B = - C = 50 D = 35
	A2.015	M112000600	SİYAH BLACK	EPDM	50	1.0 - 3.5 mm	A = 120 B = 160 C = 60 D = 60
	A2.051	-	SİYAH BLACK	EPDM	50	1.0 - 3.0 mm	A = - B = - C = 30 D = 60

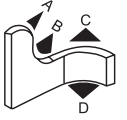

METAL TAKVİYELİ BAGAJ FİTİLLERİ / REAR-LID PROFILES WITH METAL CARRIER

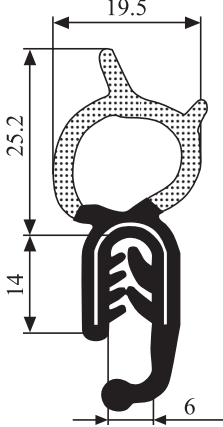
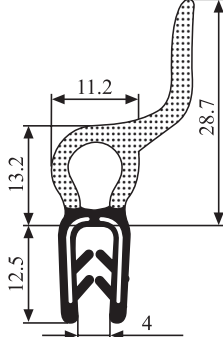
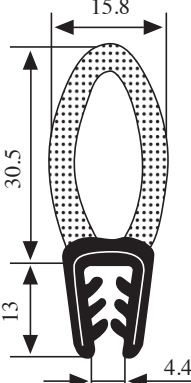
Teknik Resim Technical Drawing	Kod Reference	Eski Kodu Old Ref.	Renk Color	Malzeme Material	Ambalaj Packing (mt.)	Sac Aralığı Grip Range	Bükme Radüsü Bending Radius
	A2.035	M112003300	SİYAH BLACK	EPDM	50	2.0 - 4.0 mm	A = - B = 200 C = 60 D = 60
	A2.042	-	SİYAH BLACK	EPDM	50	1.5 - 3.0 mm	A = 80 B = - C = 30 D = 50
	A2.080	-	SİYAH BLACK	EPDM	50	2.0 - 4.0 mm	A = 110 B = - C = 20 D = 20

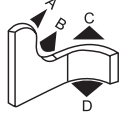

METAL TAKVİYELİ BAGAJ FİTİLLERİ / REAR-LID PROFILES WITH METAL CARRIER

Teknik Resim Technical Drawing	Kod Reference	Eski Kodu Old Ref.	Renk Color	Malzeme Material	Ambalaj Packing (mt.)	Sac Aralığı Grip Range	Bükme Radüsü Bending Radius
	A3.040	-	SİYAH BLACK	EPDM	50	1 - 2 mm	A = 110 B = 50 C = - D = 110
	A3.001	M111007100	SİYAH BLACK	EPDM	50	2.0 - 4.0 mm	A = - B = 50 C = 250 D = -
	A3.004	M112003200	SİYAH BLACK	EPDM	50	2.0 - 5.0 mm	A = 150 B = 50 C = 200 D = 180
	A3.002	M111011200	SİYAH BLACK	EPDM	50	2.0 - 4.0 mm	A = 50 B = 50 C = - D = -
	A3.003	M112001000	SİYAH BLACK	EPDM	50	1.0 - 2.0 mm	A = 80 B = 120 C = - D = -

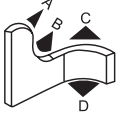

METAL TAKVİYELİ BAGAJ FİTİLLERİ / REAR-LID PROFILES WITH METAL CARRIER

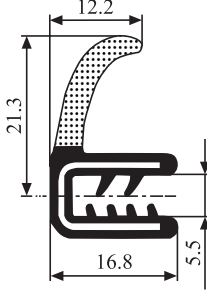
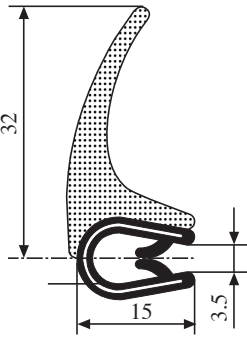
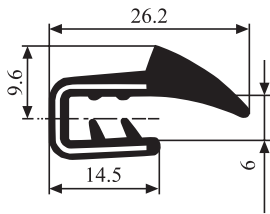
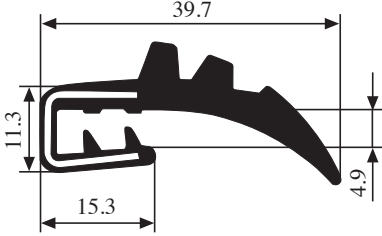
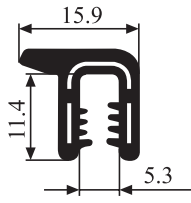
Teknik Resim Technical Drawing	Kod Reference	Eski Kodu Old Ref.	Renk Color	Malzeme Material	Ambalaj Packing (mt.)	Sac Aralığı Grip Range	Bükme Radüsü Bending Radius
	A3.005	M111011700	SİYAH BLACK	EPDM	50	2.0 - 4.0 mm	A = 100 B = 50 C = 140 D = 220
	A3.028	-	SİYAH BLACK	EPDM	25	1.0 - 3.0 mm	A = 30 B = 20 C = 80 D = -
	A3.007	M111005700	SİYAH BLACK	EPDM	50	2.0 - 4.0 mm	A = - B = - C = 50 D = 50
	A3.038	-	SİYAH BLACK	EPDM	25	3.0 - 4.0 mm	A = - B = - C = 50 D = 50
	A3.017	-	SİYAH BLACK	EPDM	100	2.5 - 5.0 mm	A = 10 B = 15 C = - D = -

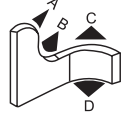

METAL TAKVİYELİ BAGAJ FİTİLLERİ / REAR-LID PROFILES WITH METAL CARRIER

Teknik Resim Technical Drawing	Kod Reference	Eski Kodu Old Ref.	Renk Color	Malzeme Material	Ambalaj Packing (mt.)	Sac Aralığı Grip Range	Bükme Radüsü Bending Radius
	A3.035	-	SİYAH BLACK	EPDM	50	4.0 - 5.0 mm	A = 40 B = 40 C = 100 D = -
	A3.022	-	SİYAH BLACK	EPDM	50	3.0 - 5.0 mm	A = 20 B = 15 C = - D = -
	A3.009	M112004000	SİYAH BLACK	EPDM	50	2.0 - 5.0 mm	A = 120 B = 50 C = 150 D = -
	A3.036	-	SİYAH BLACK	EPDM	100	3.0 - 4.0 mm	A = 100 B = - C = 30 D = 30
	A3.006	M111004900	SİYAH BLACK	EPDM	50	2.0 - 4.0 mm	A = - B = - C = 20 D = 30

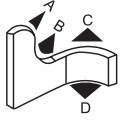

METAL TAKVİYELİ BAGAJ FİTİLLERİ / REAR-LID PROFILES WITH METAL CARRIER

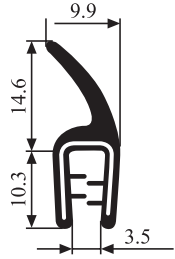
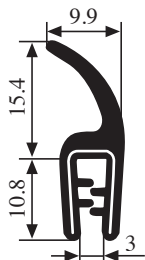
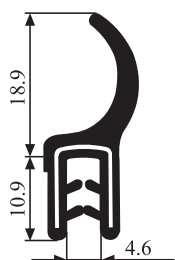
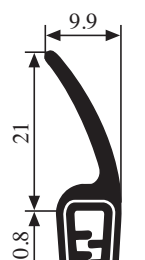
Teknik Resim Technical Drawing	Kod Reference	Eski Kodu Old Ref.	Renk Color	Malzeme Material	Ambalaj Packing (mt.)	Sac Aralığı Grip Range	Bükme Radüsü Bending Radius
	A3.016	-	SİYAH BLACK	EPDM	50	1.0 - 3.0 mm	A = 25 B = - C = 15 D = 15
	A3.041	-	SİYAH BLACK	EPDM	50	1.0 - 2.0 mm	A = - B = 120 C = 30 D = 80
	A3.011	M223103200	SİYAH BLACK	EPDM	50	1.5 - 3.0 mm	A = - B = - C = 30 D = 30
	A3.042	-	SİYAH BLACK	EPDM	50	1.0 - 2.0 mm	A = - B = 120 C = 30 D = 80

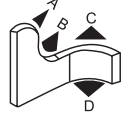

METAL TAKVİYELİ BAGAJ FİTİLLERİ / REAR-LID PROFILES WITH METAL CARRIER

Teknik Resim Technical Drawing	Kod Reference	Eski Kodu Old Ref.	Renk Color	Malzeme Material	Ambalaj Packing (mt.)	Sac Aralığı Grip Range	Bükme Radüsü Bending Radius
	A3.025	M112004800	SİYAH BLACK	EPDM	50	1.5 - 2.5 mm	A = - B = - C = 20 D = 20
	A3.010	M112004800	SİYAH BLACK	EPDM	50	1.5 - 3.0 mm	A = - B = - C = 50 D = 50
	A3.019	-	SİYAH BLACK	EPDM	30	1.5 - 4.0 mm	A = - B = - C = 15 D = 15
	A3.018	-	SİYAH BLACK	EPDM	30	2.0 - 5.0 mm	A = 75 B = - C = 15 D = 15

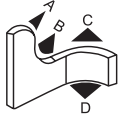

METAL TAKVİYELİ BAGAJ FİTİLLERİ / REAR-LID PROFILES WITH METAL CARRIER

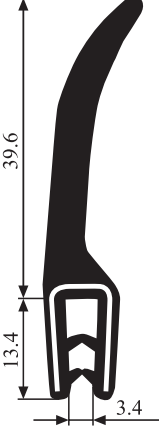
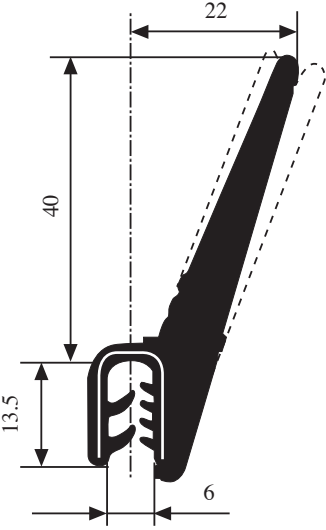
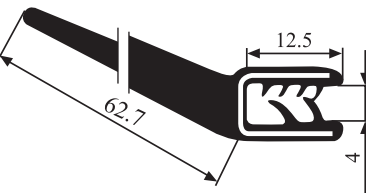
Teknik Resim Technical Drawing	Kod Reference	Eski Kodu Old Ref.	Renk Color	Malzeme Material	Ambalaj Packing (mt.)	Sac Aralığı Grip Range	Bükme Radüsü Bending Radius
	A3.008	M111011400	SİYAH BLACK	EPDM	50	1.5 - 3.0 mm	A = - B = - C = 30 D = 30
	A3.029	-	SİYAH BLACK	EPDM	25	3.0 - 5.0 mm	A = - B = - C = 20 D = 20
	A3.021	-	SİYAH BLACK	EPDM	30	1.5 - 4.0 mm	A = - B = - C = 15 D = 15

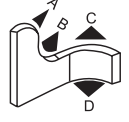

METAL TAKVİYELİ BAGAJ FİTİLLERİ / REAR-LID PROFILES WITH METAL CARRIER

Teknik Resim Technical Drawing	Kod Reference	Eski Kodu Old Ref.	Renk Color	Malzeme Material	Ambalaj Packing (mt.)	Sac Aralığı Grip Range	Bükme Radüsü Bending Radius
	A3.012	-	SİYAH BLACK	EPDM	150	1.0 - 2.0 mm	A = 30 B = 15 C = 15 D = 15
	A3.033	-	SİYAH BLACK	EPDM	100	2.0 - 3.0 mm	A = 10 B = 10 C = 10 D = 10
	A3.026	-	SİYAH BLACK	EPDM	100	1.5 - 4.0 mm	A = 60 B = - C = 20 D = -
	A3.014	M111008400	SİYAH BLACK	EPDM	150	1.0 - 3.0 mm	A = 60 B = 60 C = 30 D = 30
	A3.015	-	SİYAH BLACK	EPDM	150	1.5 - 3.5 mm	A = 15 B = 15 C = 5 D = 5

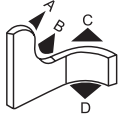

METAL TAKVİYELİ BAGAJ FİTİLLERİ / REAR-LID PROFILES WITH METAL CARRIER

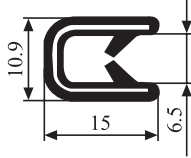
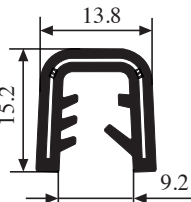
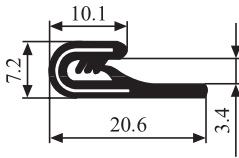
Teknik Resim Technical Drawing	Kod Reference	Eski Kodu Old Ref.	Renk Color	Malzeme Material	Ambalaj Packing (mt.)	Sac Aralığı Grip Range	Bükme Radüsü Bending Radius
	A3.013	M111001000	SİYAH BLACK	EPDM	150	2.0 - 4.0 mm	A = 70 B = 70 C = 30 D = 30
	A3.030	-	SİYAH BLACK	EPDM	100	7.0 - 8.0 mm	A = 30 B = 30 C = 30 D = 30
	A3.023	-	SİYAH BLACK	EPDM	100	1.0 - 2.0 mm	A = - B = - C = 40 D = 40



TAKVİYESİZ KOEKSTRÜZYON PROFİLLER COEXTRUDED PROFILES WITHOUT REINFORCEMENT

Farklı özelliklerdeki iki karışımdan üretilen profillerdir.

Malzeme

- EPDM Kauçuk, 70 ± 5 Shore A Siyah
- EPDM Sünger, 0.55 gr/cm³, Siyah

This section contains the profiles that are produced with two different compounds.

Material

- EPDM Rubber, 70 ± 5 Shore A Black
- EPDM Sponge Rubber, 0.55 gr/cm³, Black

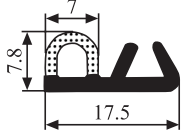
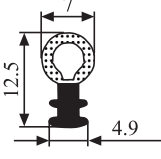
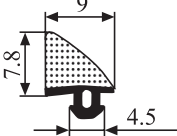
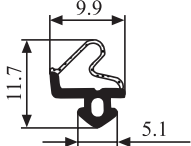
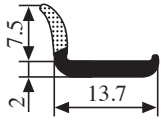
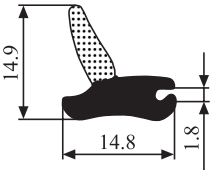
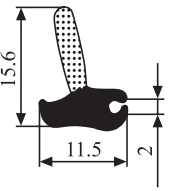

KOEKSTRÜZYON PROFİLLER - TAKVİYESİZ / CO-EXTRUDED PROFILES - WITHOUT REINFORCEMENT

Teknik Resim Technical Drawing	Kod Reference	Eski Kodu Old Ref.	Renk Color	Malzeme Material	Ambalaj Packing (mt.)
	A4.001	M121000100	SİYAH BLACK	EPDM	200
	A4.002	M121000200	SİYAH BLACK	EPDM	200
	A4.003	M121001200	SİYAH BLACK	EPDM	250
	A4.004	M121001300	SİYAH BLACK	EPDM	325
	A4.047	-	SİYAH BLACK	EPDM	150
	A4.005	M121000900	SİYAH BLACK	EPDM	100
	A4.006	M121001000	SİYAH BLACK	EPDM	100

KOEKSTRÜZYON PROFİLLER- TAKVİYESİZ / CO-EXTRUDED PROFILES - WITHOUT REINFORCEMENT

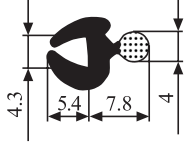
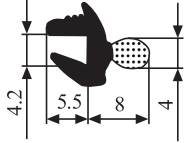
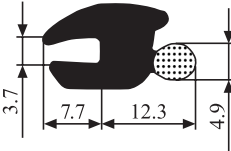
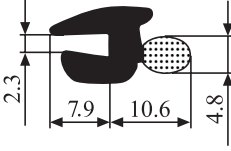
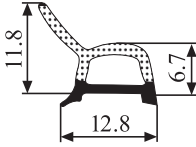
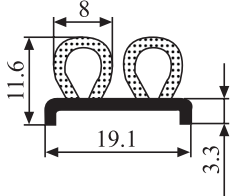
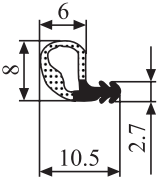
Teknik Resim Technical Drawing	Kod Reference	Eski Kodu Old Ref.	Renk Color	Malzeme Material	Ambalaj Packing (mt.)
	A4.007	M121001500	SİYAH BLACK	EPDM	200
	A4.008	M121001600	SİYAH BLACK	EPDM	200
	A4.009	M121001800	SİYAH BLACK	EPDM	100
	A4.010	M121002900	SİYAH BLACK	EPDM	100
	A4.043	-	SİYAH BLACK	EPDM	100
	A4.011	M121002400	SİYAH BLACK	EPDM	100
	A4.012	M121002500	SİYAH BLACK	EPDM	100

KOEKSTRÜZYON PROFİLLER - TAKVİYESİZ / CO-EXTRUDED PROFILES - WITHOUT REINFORCEMENT

Teknik Resim Technical Drawing	Kod Reference	Eski Kodu Old Ref.	Renk Color	Malzeme Material	Ambalaj Packing (mt.)
	A4.046	-	SİYAH BLACK	EPDM	50
	A4.013	M121002600	SİYAH BLACK	EPDM	50
	A4.014	M121001900	SİYAH BLACK	EPDM	50
	A4.015	M121002300	SİYAH BLACK	EPDM	50
	A4.016	M121001400	SİYAH BLACK	EPDM	50

KOEKSTRÜZYON PROFİLLER- TAKVİYESİZ / CO-EXTRUDED PROFILES - WITHOUT REINFORCEMENT

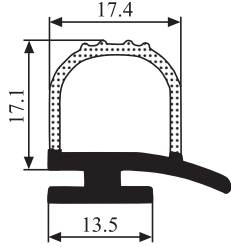
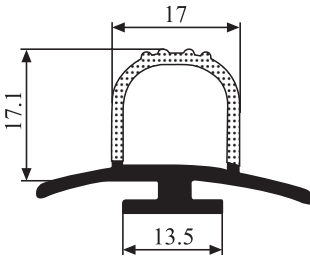
Teknik Resim Technical Drawing	Kod Reference	Eski Kodu Old Ref.	Renk Color	Malzeme Material	Ambalaj Packing (mt.)
	A4.045	-	SİYAH BLACK	EPDM	50
	A4.017	M121001401	SİYAH BLACK	EPDM	50
	A4.035	-	SİYAH BLACK	EPDM	50
	A4.044	-	SİYAH BLACK	EPDM	50
	A4.040	-	SİYAH BLACK	EPDM	50

KOEKSTRÜZYON PROFİLLER - TAKVİYESİZ / CO-EXTRUDED PROFILES - WITHOUT REINFORCEMENT

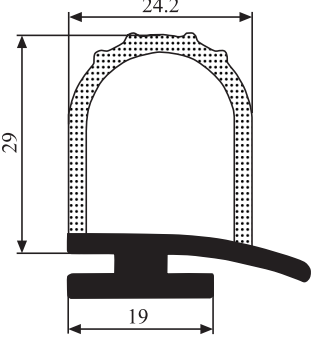
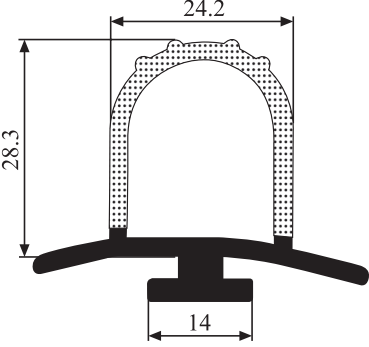
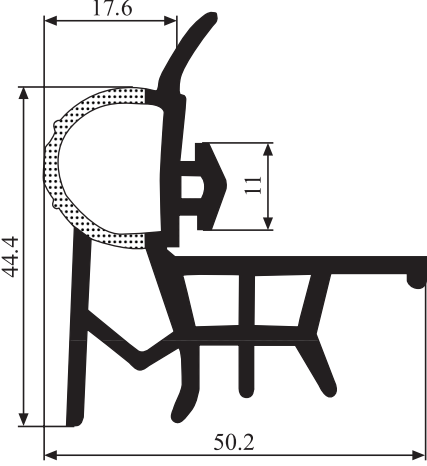
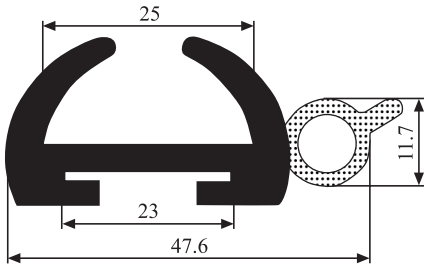
Teknik Resim Technical Drawing	Kod Reference	Eski Kodu Old Ref.	Renk Color	Malzeme Material	Ambalaj Packing (mt.)
	A4.018	M121001402	SİYAH BLACK	EPDM	50
	A4.036	-	SİYAH BLACK	EPDM	50
	A4.019	M121002700	SİYAH BLACK	EPDM	2
	A4.020	M121002000	SİYAH BLACK	EPDM	40

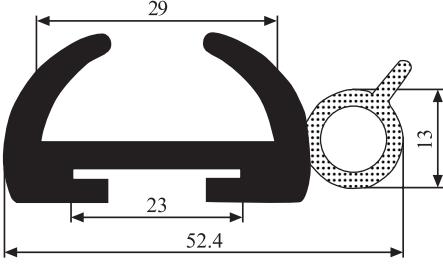
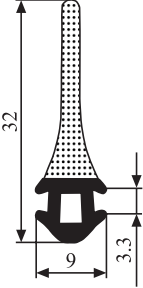
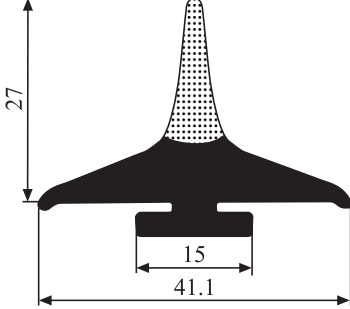
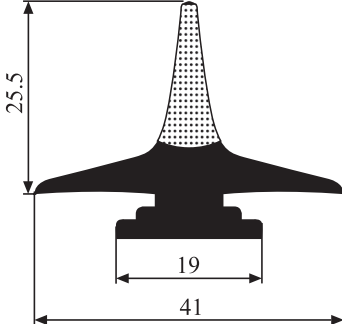

KOEKSTRÜZYON PROFİLLER- TAKVİYESİZ / CO-EXTRUDED PROFILES - WITHOUT REINFORCEMENT

Teknik Resim Technical Drawing	Kod Reference	Eski Kodu Old Ref.	Renk Color	Malzeme Material	Ambalaj Packing (mt.)
	A4.021	M121002100	SİYAH BLACK	EPDM	40
	A4.022	M121000500	SİYAH BLACK	EPDM	100
	A4.023	M121003000	SİYAH BLACK	EPDM	25
	A4.034	-	SİYAH BLACK	EPDM	50

KOEKSTRÜZYON PROFİLLER - TAKVİYESİZ / CO-EXTRUDED PROFILES - WITHOUT REINFORCEMENT

Teknik Resim Technical Drawing	Kod Referance	Eski Kodu Old Ref.	Renk Color	Malzeme Material	Ambalaj Packing (mt.)
	A4.024	M121002200	SİYAH BLACK	EPDM	100
	A4.025	M121000300	SİYAH BLACK	EPDM	50
	A4.026	M121000400	SİYAH BLACK	EPDM	50
	A4.027	M121000600	SİYAH BLACK	EPDM	40
	A4.028	M121000700	SİYAH BLACK	EPDM	50

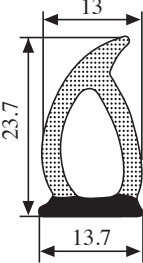
KOEKSTRÜZYON PROFİLLER- TAKVİYESİZ / CO-EXTRUDED PROFILES - WITHOUT REINFORCEMENT

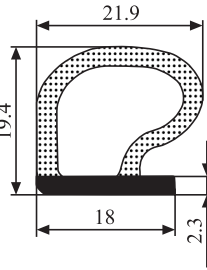
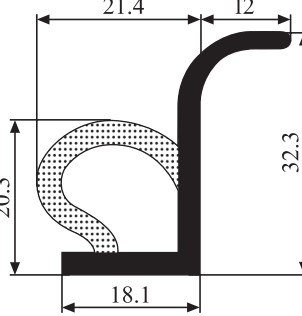
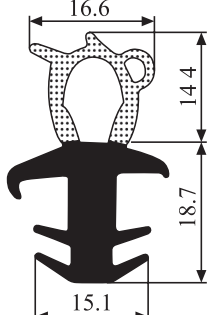
Teknik Resim Technical Drawing	Kod Reference	Eski Kodu Old Ref.	Renk Color	Malzeme Material	Ambalaj Packing (mt.)
	A4.049	-	SİYAH BLACK	EPDM	50
	A4.038	-	SİYAH BLACK	EPDM	50
	A4.029	M121000800	SİYAH BLACK	EPDM	50
	A4.042	-	SİYAH BLACK	EPDM	30
	A4.039	-	SİYAH BLACK	EPDM	30

KOEKSTRÜZYON PROFİLLER - TAKVİYESİZ / CO-EXTRUDED PROFILES - WITHOUT REINFORCEMENT

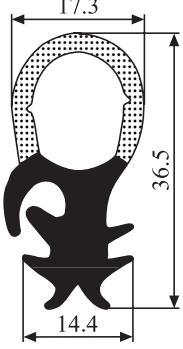
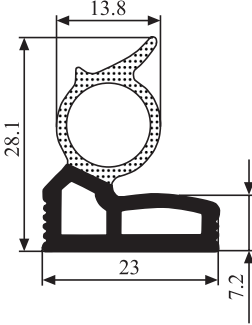
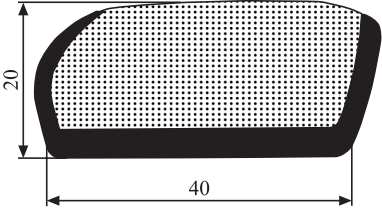
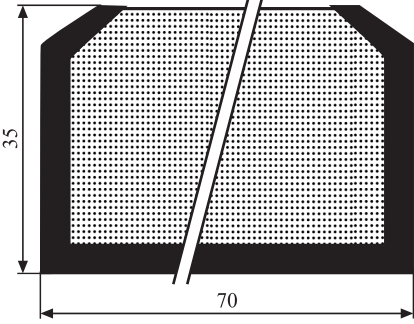
Teknik Resim Technical Drawing	Kod Reference	Eski Kodu Old Ref.	Renk Color	Malzeme Material	Ambalaj Packing (mt.)
	A4.030	M121002800	SİYAH BLACK	EPDM EPDM	50
	A4.031	M121001100	SİYAH BLACK	EPDM	50
	A4.032	M121003100	SİYAH BLACK	EPDM	25
	A4.033	M121001700	SİYAH BLACK	EPDM	25

KOEKSTRÜZYON PROFİLLER- TAKVİYESİZ / CO-EXTRUDED PROFILES - WITHOUT REINFORCEMENT

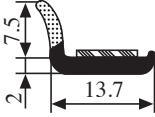
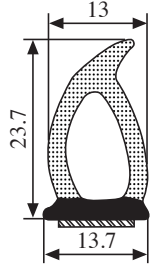
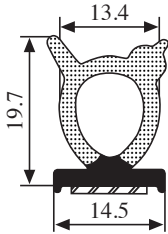
Teknik Resim Technical Drawing	Kod Reference	Eski Kodu Old Ref.	Renk Color	Malzeme Material	Ambalaj Packing (mt.)
	A5.001	-	SIYAH BLACK	EPDM Adhesive Tape	150
	A5.002	-	SIYAH BLACK	EPDM Adhesive Tape	50
	A5.003	-	SIYAH BLACK	EPDM Adhesive Tape	50